

DIS2116

Scale electronics
(NAWI)



Contents

Typographical conventions	6
Important information	7
Safety instructions	8
1 Introduction and appropriate use	9
2 Characteristic features	10
3 Mechanical construction and scope of supply	11
3.1 Scope of delivery	11
3.2 Accessories, to be ordered separately	12
4 Scale commissioning overview	13
4.1 Initial commissioning	13
4.2 NAWI application	14
4.3 NAWI application (vehicle scale)	15
5 Electrical connections	16
5.1 References	16
5.2 Cable connection	16
5.3 Cable preparation	17
5.3.1 DIS2116 connection with C16i	18
5.3.2 VKD2R-8 connection with DIS2116 and C16i	19
5.4 Load cell connection	20
5.5 Supply voltage	20
5.6 Voltage outputs	20
5.7 RS-485 interface (terminal block 1)	21
5.8 Terminal block K1 assignments	22
5.9 RS-232 interface (COM2)	23
5.10 RS-232 interface (COM3)	23
5.11 RS-232 interface (COM4)	24
5.12 PS/2 keyboard interface	24
5.13 USB printer interface	24
5.14 Interface (COM5)	24
6 Operating and display functions	25
6.1 Device view	25
6.2 Control elements	26
6.3 Display	26
7 Basic scale functions	28
7.1 Switching on and off	28
7.2 Zero setting the scale	29
7.3 Gross/Net selection	30
7.4 10-fold resolution	30

7.5	Taring	31
7.6	Manual tare function	31
7.7	Zero on start-up	32
7.8	Error displays	32
7.9	Standstill recognition	33
8	Parameter menu	34
8.1	Calling the parameter menu	34
8.2	The main menu	35
8.3	Navigation in the parameter menu	36
8.3.1	Navigation via device keys	36
8.3.2	Navigation via external keyboard	37
8.4	Full menu structure	38
8.4.1	Parameter menu "INFORMATION"	38
8.4.2	Parameter menu "PRINT"	39
8.4.3	Parameter menu "LIMIT VALUE"	41
8.4.4	Parameter menu "FILTER"	42
8.4.5	Parameter menu "COMMUNICATION"	43
8.4.6	Parameter menu "PRINT PROTOCOL"	46
8.4.7	Parameter menu "CLOCK"	47
8.4.8	Parameter menu "FUNCTION KEYS"	48
8.4.9	Parameter menu "DISPLAY"	49
8.4.10	Parameter menu "FUNCTION TEST"	50
8.4.11	Parameter menu "MODE"	52
8.4.12	Parameter menu "SCALE CONFIGURATION"	55
8.4.13	Parameter menu "SCALE PARAMETERS"	56
8.4.14	Parameter menu "OFF-CENTER LOAD COMPENSATION"	61
8.4.15	Parameter menu "FACTORY SETTINGS"	62
9	Filter selection	64
10	Scale adjustment	65
10.1	Configuration of the load cells	65
10.2	Structure of a scale segment	66
10.3	Prerequisites for scale adjustment	67
10.4	Scale adjustment with maximum capacity (standard method, calibration weight = nominal (rated) value)	68
10.5	Scale adjustment with partial load (calibration weight = 20% (5%) ... 120 % nominal value) ..	69
10.6	Adjustment without calibration weight (computational adjustment)	70
10.7	Adjustment with digital off-center load compensation	72
10.7.1	Off-center load compensation mode "SIMPLE"	73
10.7.2	Off-center load compensation mode "AVERAGE"	75
10.7.3	Off-center load compensation mode "PRECISE"	77
10.7.4	Off-center load compensation mode "INPUT"	79
10.8	Multi-range weighing machine	80
10.9	Taking gravitational acceleration into account	80

11	Linearization	81
12	Legal-for-trade applications	83
13	Vehicle scale	86
13.1	Activate "Vehicle scale" operating mode	86
13.2	Edit database	87
13.2.1	Editing vehicle data	88
13.2.2	x Delete vehicle	89
13.2.3	□ Create vehicle	89
13.3	Vehicle weighing mode "ARRIVAL/DEPARTURE"	90
14	Print function	92
14.1	Activating the printer interface	92
14.2	DIS2116 – printer connection	93
14.3	Print protocol selection	93
14.4	Print protocols	94
14.5	Starting the printing process	99
14.6	Automatic printing	100
15	Interface for a second display	101
15.1	Activating COM4 for a second display	101
16	Limit values	104
17	Alibi and calibration memory	105
17.1	Reading the stored files	105
17.2	SD memory card	106
18	Graphic display	108
18.1	Oscilloscope	108
18.2	Center of gravity	110
19	Parameter factory settings	111
20	Monitoring functions and error messages	112
20.1	Monitoring functions	112
20.2	Error messages	113
21	Specifications	118
22	Dimensions	121
22.1	DIS2116 and panel frame cutout dimensions	121
22.2	Desktop housing, also for wall-mounting (1-TG2116)	122
	Index	123

Typographical conventions

For clear identification and improved legibility, the following conventions have been used in this documentation:



IMPORTANT *Important paragraphs are marked with this symbol.*



TIP Paragraphs with the marking below contain application tips or other information that is useful to you.

Italics Indicates external documents and files.

“MODE” All menus and menu commands appear in quotes, here the main menu “MODE”.

“ENTER” Quotes and italics are used for keys, input fields and user input.

TAR Bold is used for communication commands.

Er1250 Underlined normal print is used for error messages.

Important information



IMPORTANT *Neither the design of the device nor any technical safety aspects may be modified without the express permission of Hottinger Baldwin Messtechnik GmbH. Any modification excludes Hottinger Baldwin Messtechnik GmbH from any and all liability for any damage resulting therefrom.*

It is strictly forbidden to carry out any repairs and soldering work on the motherboards or to replace any components. Repairs may only be carried out by persons authorized by Hottinger Baldwin Messtechnik GmbH.

Before connecting any cables and when replacing the battery for the real-time clock, the device must be disconnected from the power supply (battery life ≥ 5 years).

The production number set at the factory cannot be changed.

Safety instructions

- There are not normally any hazards associated with the product, provided the notes and instructions for project planning, assembly, appropriate operation and maintenance are observed.
- It is essential to comply with the safety and accident prevention regulations specific to the particular application.
- Installation and start-up must only be carried out by suitably qualified personnel.
- Do not allow damp and dirt to get inside the device when connecting the cables.
- When connecting the cables, take action to prevent electrostatic discharge as this may damage the electronics.
- The required power supply for the device is an extra-low voltage (10–30 V) with safe disconnection from the mains.
- When connecting additional devices, comply with the safety requirements.
- The ground connections of the supply voltage, the interfaces and the load cell cable shield are interconnected in the device. If the potentials of the devices to be connected are different, suitable steps must be taken to isolate the signals (such as using an optocoupler).
- Shielded cables must be used for all connections apart from the supply voltage (see note below). The shield must be connected to the provided terminals (Section 5.3, Page 17).
- The use of unshielded cables for the voltage supply is only permissible for cables with a maximum length of 30 m, laid inside buildings. If cables are longer or are installed outside buildings, shielded cables must be used (as per EN 61326-1).
- To compensate for potential differences, the metal housing of the DIS2116 must be connected to the scale structures as well as to the ground potential of the connected devices by a low-resistance equalizing conductor. This is unnecessary if a potential difference of 35 V is not exceeded.
- In the device, the reference ground (GND) of all the signals and the supply voltage is connected directly to the cable shield connection but not to the housing.
- Connection to a wide-ranging supply network is not permitted as this often causes interfering voltage peaks to be coupled into the electronics. Instead, a local supply must be provided for the DIS2116 (even when grouped).
- The front foil is made from high-quality materials, providing a service life appropriate to the external conditions. The keys must only be operated by hand; under no circumstances must pointed objects be used to press them.

1 Introduction and appropriate use

This Operating Manual contains detailed information both on operation and on the setting options of the DIS2116 weighing electronics.

The DIS2116 is designed for use in industrial applications, for example

- as a verifiable main display for up to 24 digital load cells (e.g. C16i) as components of a non-automatic scale (NAWI)
- as a vehicle scale with max. 3 segments as a compound weighing machine

Use for any purpose other than the above is deemed to be non-designated use.



IMPORTANT *In the case of legal-for-trade use, national legal and safety regulations must be complied with.*

2 Characteristic features

The DIS2116 is a digital display unit for connection to digital load cells.

The DIS2116 has available:

- RS-485 4-wire connection for up to 24 digital load cells
- Menu for a vehicle scale with up to 3 segments and max. 12 load cells in segment 1 and max. 8 load cells in segments 2 and 3
- Encrypted transmission of measured values between DIS2116 and load cells in legal-for-trade mode
- COM port for serial communication with a PC / PLC (RS-232)
- COM port for a printer (RS-232 or USB)
- COM port for an external large-scale display (RS-232)
- COM port for connection to fieldbuses
- PS/2 connection for an external keyboard
- Internal SD card as alibi memory for print data and settings
- Real-time clock with battery buffering
- Supply voltage range 10 ... 30 V_{DC}
- Voltage output to power supply of digital load cells

The electronics are set and parameterized via keyboard or interface.

Further features:

- Usable as a one, two or three-range scale
- Menu functions can be disabled / enabled
- Filter selection
- Max. capacity adjustment, partial load adjustment
- Zero on start-up
- Automatic zero tracking
- Weighing range linearization
- Various print functions
- Numerous monitoring and error detection functions

3 Mechanical construction and scope of supply

3.1 Scope of delivery



Fig. 3.1: DIS2116 view

- DIS2116 weighing electronics in aluminum housing for panel mounting
- Adhesive label for closing the opening for the calibration pushbutton and labeling strips
- Eight labeling strips for creating the scale type plate
- Two 8 pin mating connectors (Phoenix Mini-Combicon mating connector 8 pin Type: MC1.5/8-ST-3.81)
- Two connector housings with strain relief (Phoenix Mini-Combicon connector housing 8 pin Type: KGG-MC 1.5/9)
- Four mounting elements for panel mounting

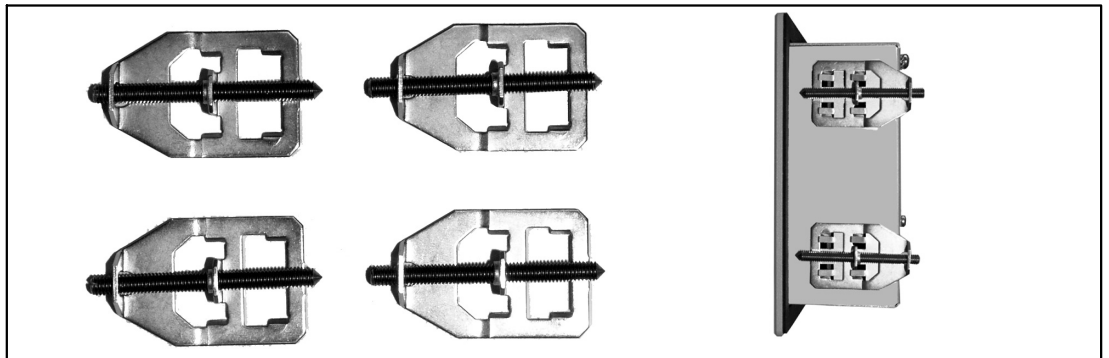

For panel-mounting the DIS2116, bend the cut-out tabs outward slightly to engage the mounting elements. Then use the threaded pins to clamp the housing to the panel.

- SD card (1 Gbyte) installed in DIS2116
- Quick Start Guide
- System CD, 1-DIS2116-DOC

3.2 Accessories, to be ordered separately

- Power supply, 15 V / 530 mA AC/DC (for max. 8 load cells)
- Desktop housing, also for wall-mounting, 1-TG2116 (for dimensions, see Section 22.2, Page 122)
- VKD2R-8 terminal box
- Cable (connection cable for C16i)

4 Scale commissioning overview

The permissible supply voltage for the DIS2116 can be in the range +10 ... 30V_{DC} and must be adequately smoothed (effective value less residual ripple >10 V).



IMPORTANT *If digital load cells, e.g. C16i, are supplied via the DIS2116 then the permissible supply voltage is +10 ... 17 V_{DC}.*

A 100 ... 240 V power supply unit (15 V / 530 mA AC/DC, for max. 8 load cells) is available as an accessory. This power unit is suitable for all digital load cells.

When properly connected with shielded cables, the DIS2116 complies with the relevant European standards and therefore carries the CE mark.

A formatted SD card with the factory setting parameters is inserted into the device.

The mechanical dimensions can be found in Chapter 22, Page 121, mounting information in Chapter 3, Page 11.

Subsequent sub-chapters provide an overview of the sequence of steps that needs to be taken to commission the scale, depending on your application:

- Initial commissioning
- DIS as component of a non-automatic counting scale (NAWI) → Section 4.2 (Page 14)
- DIS as component of a vehicle scale → Section 4.3 (Page 15)

This overview includes information on the respective chapters and sections in this Operating Manual.

4.1 Initial commissioning

- Mounting the device, Chapter 3 (Page 11)
- Connecting the load cell(s), Chapter 5, Section 5.4 (Page 20)
- Connecting the supply voltage, Chapter 5, Section 5.5 (Page 20)
- Connecting the serial connections, Chapter 5, Section 5.8 (Page 22) or Section 5.9 (Page 23)
- Switching on the device, Chapter 7, Section 7.1 (Page 28)
- Configuration of the load cells, Chapter 10, Section 10.1 (Page 65)

4.2 NAWI application

- Mounting the device, Chapter 3 (Page 11)
- Connecting the digital load cell(s), Section 5.4 (Page 20)
- Connecting the supply voltage, Section 5.5 (Page 20)
- Connecting the serial connections, Section 5.8 (Page 22) or Section 5.9 (Page 23)
- Switching on the device, Section 7.1 (Page 28)
- Calling the parameter menu via the hidden keys, Section 8.1 (Page 34)
- Enabling all menu functions, Section 8.4.11 (Page 52)
- Configuration of the load cells, Section 10.1 (Page 65)
- Setting the weighing range, Section 8.4.13 (Page 56)
- Setting the correct filters, Chapter 9 (Page 64)
- Adjusting the weighing range, Chapter 10 (Page 65)
- Digital off-center load compensation (when required), Section 10.7 (Page 72)
- Linearization (only when required), Chapter 11 (Page 81)
- Settings for legal-for-trade applications, Chapter 12 (Page 83)
- Setting parameters for the serial interfaces, Section 8.4.5 (Page 43), Chapter 15 (Page 101) or Chapter 16 (Page 104)
- Setting the date and time, Section 8.4.7 (Page 47)
- Disabling menu functions (as required), Section 8.4.11 (Page 52)
- Filling out the labeling strip, securing the labeling strip, Chapter 12 (Page 83)
- Checking settings and functions

4.3 NAWI application (vehicle scale)

- Mounting the device, Chapter 3 (Page 11)
- Connecting the load cell(s), Section 5.4 (Page 20)
- Connecting the supply voltage, Section 5.5 (Page 20)
- Connecting the serial connections, Section 5.8 (Page 22) or Section 5.9 (Page 23)
- Switching on the device, Section 7.1 (Page 28)
- Calling the parameter menu via the hidden keys, Section 8.1 (Page 34)
- Enabling all menu functions, Section 8.4.11 (Page 52)
- Configuration of the load cells, Section 10.1 (Page 65)
- Setting the weighing range, Section 8.4.13 (Page 56)
- Setting the correct filters, Chapter 9 (Page 64)
- Adjusting the weighing range, Chapter 10 (Page 65)
- Digital off-center load compensation (only when required), Section 10.7 (Page 72)
- Linearization (only when required), Chapter 11 (Page 81)
- Setting the vehicle scale function, Chapter 13 (Page 86)
- Setting parameters for the serial interfaces, Section 8.4.5 (Page 43), Chapter 15 (Page 101) or Chapter 16 (Page 104)
- Setting the date and time, Section 8.4.7 (Page 47)
- Disabling menu functions (as required), Section 8.4.11 (Page 52)
- Filling out the labeling strip, securing the labeling strip, Chapter 12 (Page 83)
- Checking settings and functions

5 Electrical connections

5.1 References

Please comply with the safety instructions at the start of this manual.

Load cells and power lines are connected by means of screw terminals on the back of the device. The terminals are fitted with wire protection and the use of wire end ferrules is recommended, particularly for the load cell cables. The assignment of the connection terminals is displayed on the back of the device.



IMPORTANT *All the ground connections are interconnected on the motherboard.*

5.2 Cable connection

All connections are accessible from the outside, the housing does not need to be opened. Strain relief for the connection cable can be provided via the supplied terminal housing. Round cables, between 5 and 7 mm in diameter, can therefore be used.

To minimize EMC problems, the individual wires from the end of the shielding to the terminal should be as short as possible.

The cable shields must be twisted together and connected to one of terminals 1.1, 1.8, 2.1 or 2.8.

5.3 Cable preparation

- Remove the outer sheath to about 20 mm.
- Twist the braided screen.
- If necessary, remove the inner sheath.
- Strip the wire ends to about 5 mm.
- Connect the wires to the terminals.

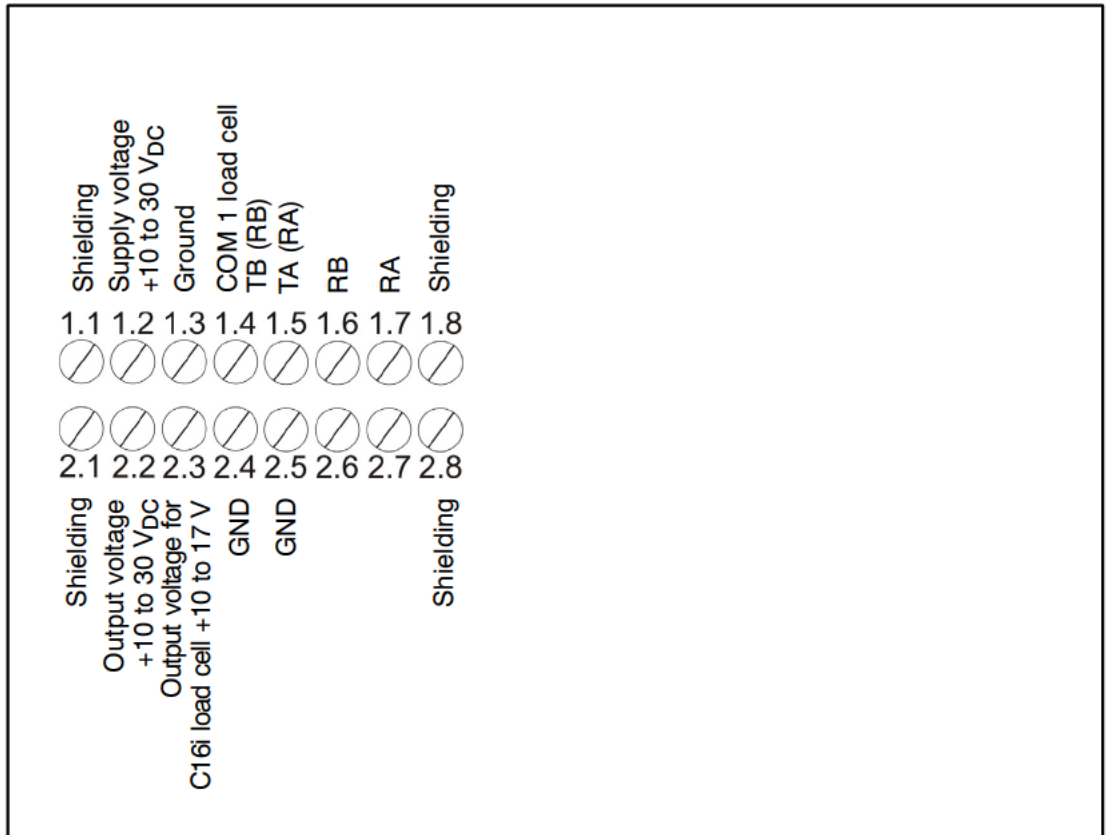
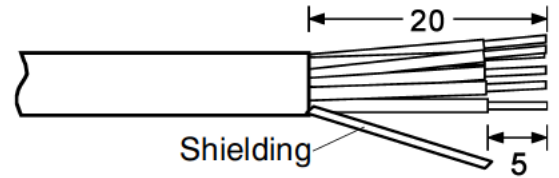

Fig. 5.1: Position of connections on terminal block K1

5.3.1. DIS2116 connection with C16i

C16i Wire colors	RS-485 4-wire	DIS2116 Terminal K1
	Shielding connection	1.1
Blue	RS-485, transmission line A (=T-)	1.7 RA (RX-)
Black	RS-485, transmission line B (=T+)	1.6 RB (RX+)
Green	RS-485, reception line A (=R-)	1.5 TA (TX-)
Gray	RS-485, reception line B (=R+)	1.4 TB (TX+)
Red	Voltage supply +, max. 17 V _{DC}	2.3 UB
White	Voltage supply ground	2.4 GND

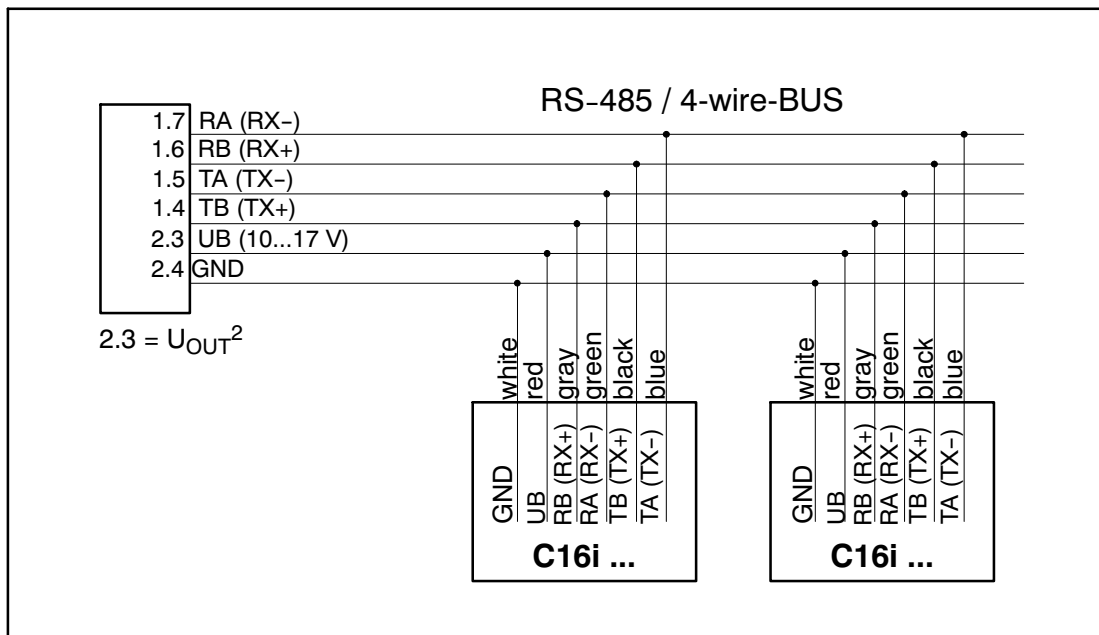

Fig. 5.2: Cable assignment

5.3.2. VKD2R-8 connection with DIS2116 and C16i

VK...	RS-485 4-wire	VK...	DIS2116
(Input, signals from C16i)		(Output)	(Terminal K1)
	Shielding connection	Shielding	1.1
TA	RS-485, transmission line A (=T-)	TA	1.7 (RA)
TB	RS-485, transmission line B (=T+)	TB	1.6 (RB)
RA	RS-485, reception line A (=R-)	RA	1.5 (TA)
RB	RS-485, reception line B (=R+)	RB	1.4 (TB)
GND	Voltage supply ground	GND	2.4
UB	Voltage supply +, max. 17 V _{DC}	UB	2.3

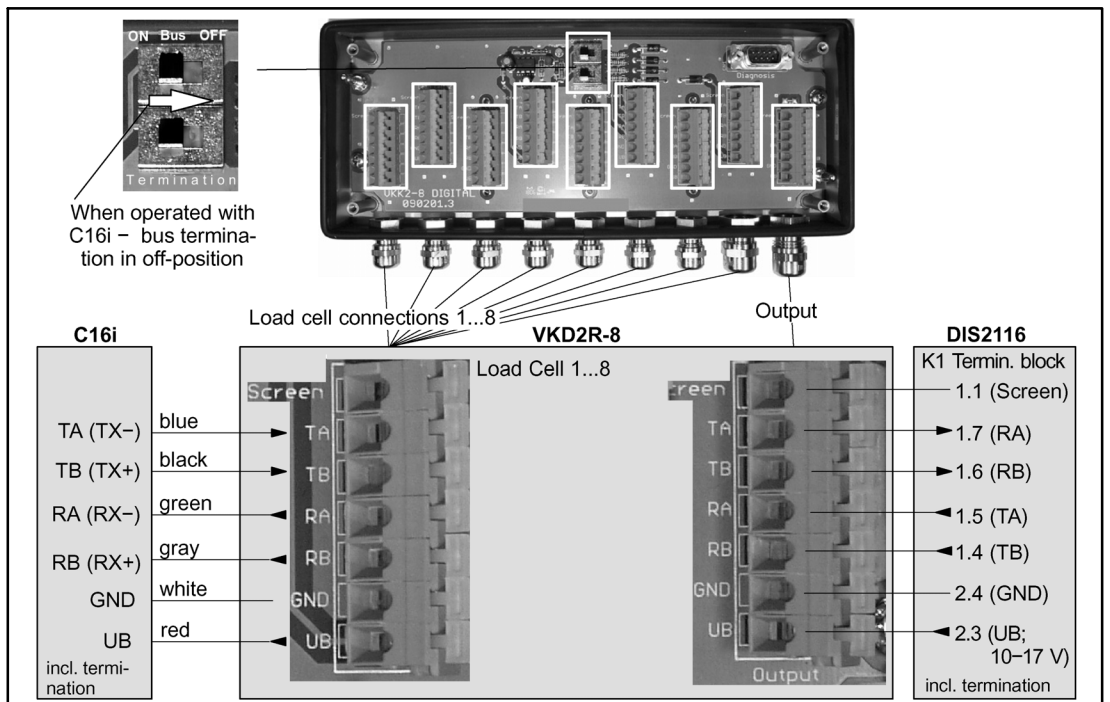



Fig. 5.3: Connection diagram of the measurement chain C16i – VKD2R-8 – DIS2116

5.4 Load cell connection

Digital load cells (C16i) etc. can be connected to the DIS2116. An RS-485 interface is available for this purpose.

The RS-485 interface can be used as a 4-wire (full duplex) or as a 2-wire (half duplex) interface.

All digital load cells (e.g. C16i) have the address 31 as the factory setting. If several load cells are connected to a scale, the load cell addresses must first be changed. Implement these settings in the parameter menu "SCALE CONFIGURATION" (Section 10.1, Page 65).

 **IMPORTANT** *Implement the configuration in the parameter menu "SCALE CONFIGURATION" after connecting the load cells.*

5.5 Supply voltage

Terminal	Function	Comments
1.2	Supply voltage	+10 ... 30 V _{DC} ¹⁾
1.3	Ground	

¹⁾ The supply voltage must be sufficiently filtered (effective value minus residual ripple > 10 V).

5.6 Voltage outputs

Terminal	Function	Comments
2.2	Output voltage 10 ... 30V	The 10 ... 30V input voltage is made available directly at the output to supply digital load cells.
2.4	GND	Ground
2.3	Output voltage 10 ...17V	This output is only used to supply C16i load cells with a maximum supply voltage of 17V. The input voltage is made available at the output up to a value of 17V. The output is switched off at higher input voltages.
2.5	GND	Ground
1.1, 1.8, 2.1, 2.8	Shielding	

5.7 RS-485 interface (terminal block 1)

The DIS2116 is the master for the connection with the digital load cells C16i (measurement chain).

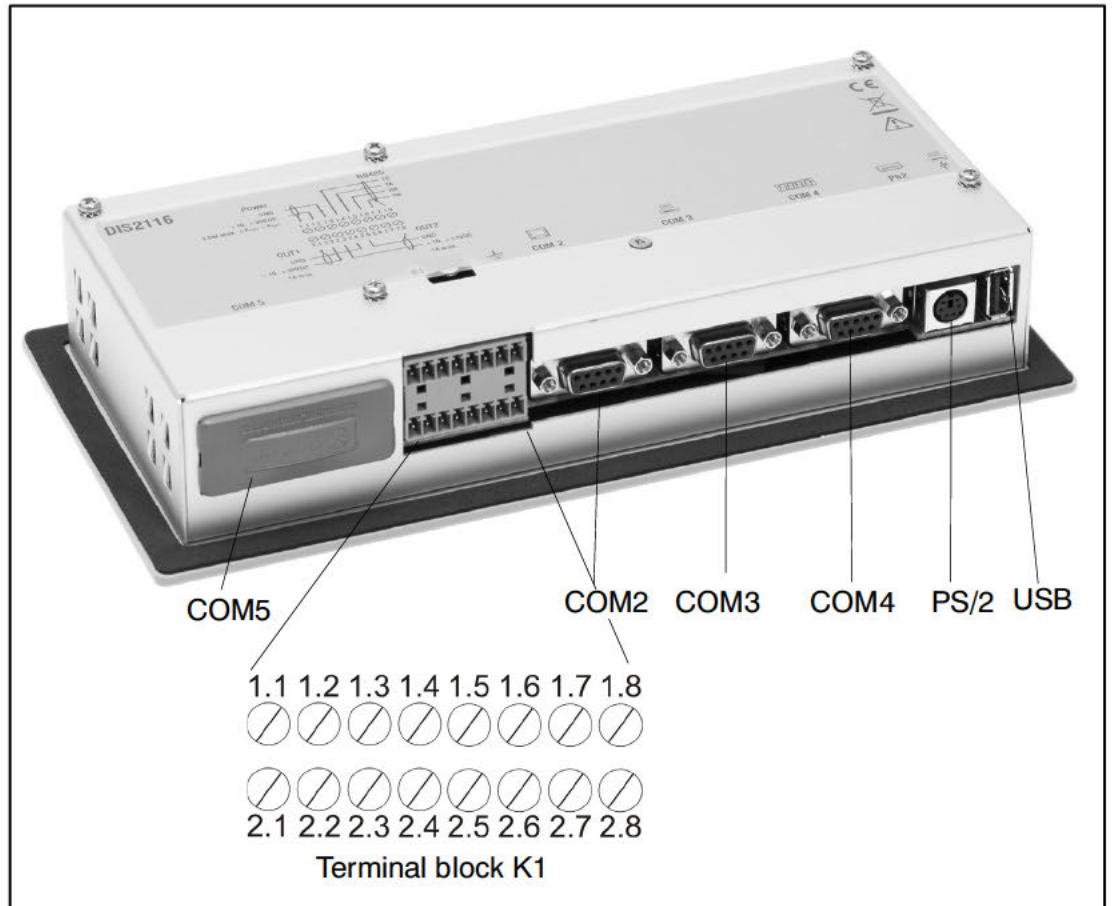

Fig. 5.4: Connection positions (back of device); for assignment, see Page 22

5.8 Terminal block K1 assignments

Terminal block K1 has the following signals:

- Supply voltage input
- Supply voltage load cells output
- Load cells interface RS-485 4-wire
- Load cells interface CAN (dependent on load cell) for future applications

Terminal	Signal			Comments
1.1,1.8 2.1,2.8	Shielding			
1.2	Supply voltage	10 ... 30 V		
1.3	Supply voltage	GND		
1.4	COM1 load cell		TB (RB)	Serial interface RS-485 Only use terminals 1.4 and 1.5 for RS-485 2-wire
1.5	COM1 load cell		TA (RA)	
1.6	COM1 load cell		RB	
1.7	COM1 load cell		RA	
2.2	Voltage output	10 ... 30 V		Output voltage= input voltage
2.3	Voltage output supply, <i>only for C16i supply</i>	10 ... 17 V		With input voltage > 17 V this output does not supply voltage
2.4, 2.5	Voltage output	GND		
2.6	COM1 load cell		CAN low	CAN interface
2.7	COM1 load cell		CAN high	

5.9 RS-232 interface (COM2)

COM2 (9-pin SUB-D socket), computer interface for connecting to a PC. The SUB-D socket is assigned so that a standard RS-232 cable can be used.

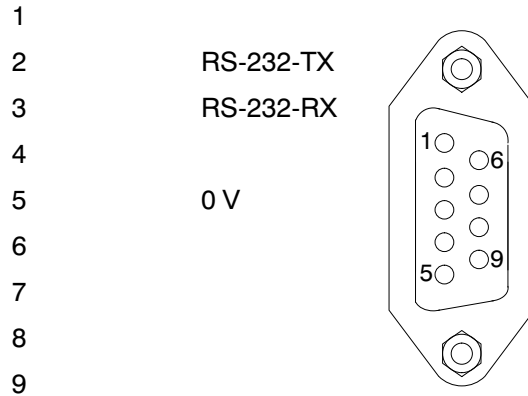

5.10 RS-232 interface (COM3)

COM3 (9-pin SUB-D socket), printer interface for connecting a serial printer. The SUB-D socket is assigned so that a standard printer cable can be used.

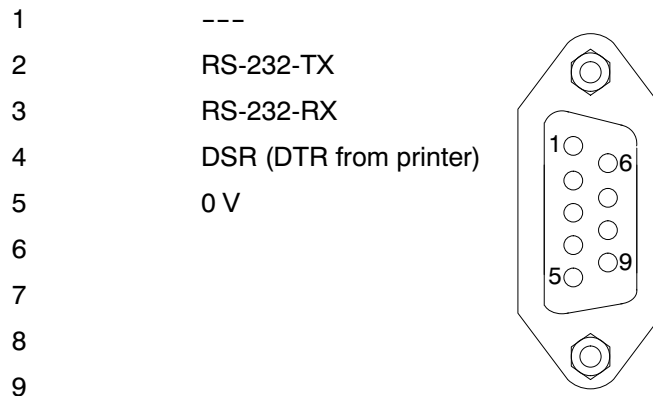

5.11 RS-232 interface (COM4)

COM4, interface for connecting a second display via a 9-pin SUB-D socket. The SUB-D socket is assigned so that a standard RS-232 cable can be used.

1	---
2	RS-232-TX
3	RS-232-RX
4	DSR (DTR from second display)
5	0 V
6	
7	
8	
9	

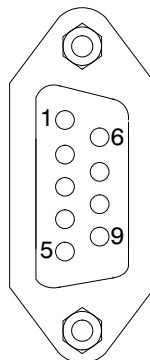

5.12 PS/2 keyboard interface

PS/2 input for connecting an external standard keyboard.

5.13 USB printer interface

USB host socket for connecting a printer

5.14 Interface (COM5)

COM5 is set up as an optional interface for a fieldbus module.

The function and assignment is described in the manual for the Anybus plug-in module.

6 Operating and display functions

6.1 Device view

The front of the DIS2116 consists of the following elements:

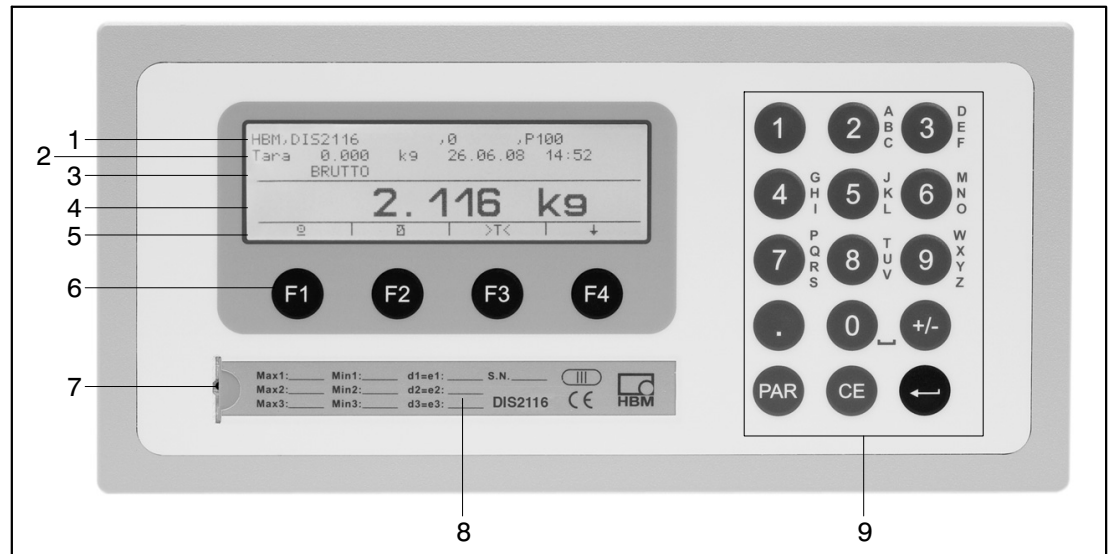





Fig. 6.1: DIS2116 front panel

1. Info line 1, configurable in the “DISPLAY → DISPLAY LINE 1” menu.
2. Info line 2, configurable in the “DISPLAY → DISPLAY LINE 2” menu.
3. Measured value status display.
4. Measured value.
5. Function line (meaning of function keys “F1” ... “F4”).
6. Function keys “F1” ... “F4”.
7. Hidden pushbutton for access to the calibration menu. The pushbutton can be accessed with a pointed object (when the label is removed). After calibration, the opening is sealed with the enclosed adhesive label or, for legal-for-trade applications, with the calibration label. Device calibration is protected in operation and can only be changed when this pushbutton is actuated.
8. Inspection window for inserting a labeling strip (for scale type plate with calibration data, device name, etc.).
9. Keyboard for entering numbers and letters.

The connections for the serial interfaces and the terminals for the connecting cables are located on the back of the device.

6.2 Control elements

- Key  = Open parameter menu
- Key  = Cancel input, leave parameter menu without accepting changes
- Key  = Apply input or setting and exit dialog
- Keys “F1” ... “F4” = The function of the keys is displayed by the text or the symbols in the function line (Fig. 6.2) in the display
- Hidden pushbutton for access to the calibration menu (see Fig. 6.1)

6.3 Display

The display consists of the following elements:





Fig. 6.2: Display

Info line 1 and Info line 2

The contents of Info lines 1 and 2 can be specified by the user (menu “DISPLAY → DISPLAY LINE 1” or “DISPLAY → DISPLAY LINE 2”).

Status line

The status line is divided into 7 horizontal segments. The following symbols or texts are displayed, where applicable:

- $\rightarrow | 1 | \leftarrow$: Displays the currently valid weighing ranges. Nothing is displayed for a single weighing range.
- GROSS, NET, NET PT Indicates which value will be displayed: A gross measured value, a net measured value or a net measured value where a manual tare is applied.
- x10 Displayed when the x10 resolution is active.
- >0< Displayed when the measured value is $0 \pm 0.25d$ (true zero).
-  1,2 Displays the overshoot of the set limit value 1 and/or 2.
- OVFL/LFT/Err + error code If a load cell is overloaded, OVFL and the load cell address are displayed, e.g. OVFL A12. LFT is displayed in legal-for-trade mode when the measured value lies outside the valid range. Err and the relevant error code are displayed when an error occurs, see Section 20.2, Page 113.
-  Indicates that the measured values are transmitted encrypted.

Measured value display

The weight value is displayed with \pm and 7 digits with decimal point.

The physical unit is displayed with max. 4 characters.

Display illumination

The LCD backlighting is always on once the power is connected.

Display contrast

The LCD display contrast can be set in the menu "DISPLAY → CONTRAST" in 21 steps, from -10 to +10. The lowest contrast is -10 and the highest +10.

7 Basic scale functions

All device functions can be controlled in one or more of the following ways:

- Front control with 19 short-stroke keys. With function keys “F1” ... “F4”, the meaning of the key is displayed in the display function line.
- An external keyboard which can be connected via the PS/2 input.
- Connecting an external computer via the COM2 serial interface.

The main scale functions (Gross/Net, Taring, Zero setting) are controlled via function keys “F1” ... “F4”. A menu is called for calibration and for additional device settings: Key  (or “F5” on external keyboard). Scale operation is not interrupted during parameter input, right up to exiting the menu. When computer commands are used for control, measurement generally continues without interruption. The exceptions to this are settling after filter selection and power failsafe storage to the EEPROM.

7.1 Switching on and off

The device is switched on once the supply voltage is applied. When the electronics are switched on, a BUS SCAN is executed initially, i.e. a check is made as to whether the load cells listed in the “PARAMETER MENU → SCALE CONFIGURATION” are present.

During initial commissioning, all digital load cells have the same address 31 (factory setting). The load cells must be individually configured before a scale adjustment can be carried out.

With verified scales, a check is made as to whether the parameters in the load cells have been changed. If the parameters are no longer identical to those during verification, an error message is displayed and no measured values are acquired or processed.

Connected load cells that are not entered in the “PARAMETER MENU → SCALE CONFIGURATION” are not taken into account.

During the BUS SCAN, the following is displayed:

- **Information line 1** The identification string consisting of the manufacturer, TYPE, serial number and software version
- **Information line 2** Date and time
- **Measured value status line** The legal-for-trade counter status (TCR) and whether the scale is verified (LFT)

Zero is automatically set during initialization if this function is activated. The actions carried out during initialization are displayed in clear text in the measured value display and the initialization progress is shown by a moving bar.

The scale must not be loaded when it is being switched on.

The device is switched off by disconnecting the supply voltage from the DIS2116.

7.2 Zero setting the scale

Press the F4 key until the symbol >0< appears above the F3 key.

Set the measured value to zero by pressing the F3 key. The displayed gross value is zero immediately after zero setting.

MODE → LFT CAPABILITY	Range of zero setting, lower limit	Range of zero setting, upper limit
NO (not legal-for-trade)	-20%	+20%
OIML, NTEP	-2%	+2%

The % figures relate to the nominal weighing range (parameter “SCALE PARAMETERS → PARAMETER → NOMINAL VALUE”)

Execution is dependent on standstill recognition (Chapter 7.9, Page 33).

The net display is deactivated.



IMPORTANT *Zero setting is only possible when the function in the “PARAMETER MENU → FUNCTION KEYS → ZERO SETTING” is ACTIVE.*

7.3 Gross/Net selection

Press key "F4" until the symbol  appears above key "F2".

Every time key "F2" is pressed, the display changes between gross and net. When selecting the net display, the last valid tare value is used again.

 **IMPORTANT** *Gross/net selection is only possible when the function in the "PARAMETER MENU → FUNCTION KEYS → GROSS/NET" is ACTIVE.*

7.4 10-fold resolution

Press key "F4" until the symbol $\times 10$ appears above key "F2".

Every time key "F2" is pressed, 10-fold resolution is activated/deactivated. This mode can be used for test purposes. The measured value is then displayed with a factor 10 higher resolution.

 **IMPORTANT** *10-fold resolution is only possible when the function in the "PARAMETER MENU → FUNCTION KEYS → 10-FOLD RESOLUTION" is ACTIVE. If the scale is set to legal-for-trade OIML or NTEP, 10-fold resolution can only be activated while key "F2" is pressed. Once "F2" is released, 10-fold resolution deactivates after about 5 seconds.*

7.5 Taring

Press key “F4” until the symbol >T< appears above key “F3”.

Pressing key “F3” stores the current gross value and deducts it from all the subsequent weight values. So immediately after taring, the displayed (net) value is zero. The tare value can be permanently displayed in the measurement value display, the setting must be made in the menu “DISPLAY → DISPLAY → LINE 1” or “DISPLAY → DISPLAY → LINE 2”. The tare value can be read in the “INFORMATION → TARE VALUE” menu item.

MODE → LEGAL-FOR-TRADE CAPABILITY	Tare range, lower limit	Tare range, upper limit
NO (not legal-for-trade)	-100%	100%
OIML, NTEP	>0	100%

The % figures relate to the nominal weighing range (parameter “SCALE PARAMETERS → PARAMETER → NOMINAL VALUE”). Execution is dependent on standstill recognition (Section 7.9, Page 33).

Taring with this key overwrites any manual tare value that may have been entered previously (PT symbol is switched off).



IMPORTANT *Taring and entering a manual tare value is only possible when the function in the “PARAMETER MENU → FUNCTION KEYS → TARING” is ACTIVE.*

7.6 Manual tare function

A manual tare value can be entered in the parameter menu “SCALE PARAMETERS → PARAMETERS → MANUAL TARE VALUE” and the application of the manual tare value switched on/off in the parameter menu “SCALE PARAMETERS → PARAMETER → MANUAL TARE MODE”, see Section 8.4.9 (Page 49) and Section 8.4.13 (Page 56).

When the “Manual tare” function is activated, the net value is formed by deducting a fixed tare value. The PT symbol in the display indicates that the net value has been formed by deducting the manual tare value. This disappears after taring with the Tare key “F3” (>T<).

The “G/N” key does not change the entered manual tare value.

Input manual tare value

Either press the “F3” (>T<) key for at least 2 seconds or one of the numerical keys to open the dialog to change the manual tare value. After a manual tare value is input, the net value is displayed with the manual tare supplement (NET PT).

If the manual tare function was activated, it will also be activated once the device is switched back on.

7.7 Zero on start-up

If this function is activated (parameter menu “SCALE PARAMETERS → PARAMETER → ZERO ON START-UP”), the unloaded scale is automatically set to zero when the DIS2116 is switched on (range of zero setting device $\pm 2 \dots 20\%$). This takes into consideration the set standstill condition.

7.8 Error displays

The permissible display range depends on the nominal (rated) value of the scale and the set mode of operation (not legal for trade / OIML / NTEP).

MODE → LEGAL-FOR-TRADE CAPABILITY	Lower display limit	Upper display limit
NO (not legal-for-trade)	-160%	+160%
OIML	-20 d	Nominal value +9d
NTEP	-2%	Nominal value +5%

The percentages relate to the nominal weighing range (“NOMINAL (RATED) VALUE” parameter).

As soon as the measured value lies outside the display range, the measured value is replaced in the display with “-----” and “LFT” is shown in the status line.

Other errors are displayed as a four-digit code with explanation, e.g.:

ERROR!

CODE 5700

No standstill

No measured value acquired

For error messages, see also Section 20.2, Page 113.

7.9 Standstill recognition

The zeroing, taring and printing functions are only executed if the value in the display is stable. This is known as standstill and is indicated by showing the unit of measurement. The condition for standstill is that the value only changes within a specific fluctuation range per time unit. With fluctuating (wind) loads or a very high scale resolution, it is quite possible that standstill will never be achieved. In this case, a more strongly damping filter or a lower resolution can be selected in the parameter setting.

The various options for standstill indication can be selected in the “SCALE PARAMETERS → PARAMETER→STANDSTILL MON.” menu, see also Section 8.4.13 (Page 56).



It is also possible to switch off the standstill conditions (but not for legal-for-trade applications). The unit is always displayed when standstill monitoring is switched off.

8 Parameter menu

8.1 Calling the parameter menu

You have the following options for calling the parameter menu:

1. Press key .

The symbol  is shown to the right in the title bar of the display: Some parameters (calibration or LFT settings) can only be changed after the hidden pushbutton has been pressed. If a plus is displayed next to the symbol (), the passcode must also be entered.

2. Pressing the hidden pushbutton (see Fig. 6.1, Page 25).

If + is shown in the display, the passcode must also be entered to obtain access to the LFT or scale adjustment parameters. Otherwise, access is enabled for the menu level of the LFT/scale adjustment parameters (parameter menus "FUNCTION KEYS", "MODE", "SCALE CONFIGURATION", "SCALE PARAMETERS", "OFF-CENTER LOAD COMPENSATION", "FACTORY SETTINGS").

3. Pressing the key "F5" on external keyboard.

This corresponds to pressing the key .

Possible access restrictions

- The six access levels (ACCESS LEVEL) enable access restriction to various parameter menus. Only specific menus are visible after an access level has been set. Access level 0 disables most menus, access level 5 enables all parameter menus, see Section 8.2 and Section 8.4.11 on Page 52. Pressing the hidden pushbutton activates the highest access level again, i.e. all parameter menus are visible again.
- If access to the menu level of the LFT/scale adjustment parameters is blocked by a passcode, input or editing is only possible after the passcode has been entered, see Section 8.4.11, Page 52. In this case, + or  are shown top right in the parameter menu.

The menus "PARAMETER MENU → MODE → ACCESS LEVEL" and "PARAMETER MENU → MODE → PASSCODE PROTECTION" are protected by the hidden pushbutton.

8.2 The main menu

To make things clearer, the parameters are grouped into several sub-menus, which can be called from the main menu. It is also possible to print out the parameters via the main menu (only when the printer interface is active). Certain parameters are not accessible in every mode of device operation, or are read-only (access level, see Section 8.4.11, Page 52). To access certain parameter menus, it is necessary to actuate a hidden pushbutton, which is only accessible once the calibration or sealing label has been removed. The symbol \mathcal{L} is therefore shown to the right in the title bar. If \mathcal{L}^+ is displayed, the passcode must also be input (passcode protection, see Section 8.4.11, Page 52).

The parameter menu contains the following items:



Access level	Main menu level	Explanation	Legal-for-trade parameter ¹⁾
0	INFORMATION	Information (Section 8.4.1)	-
1	PRINT	Print (Section 8.4.2)	-
2	LIMIT VALUE	Limit values (Section 8.4.3)	-
4	FILTER	Filter (Section 8.4.4)	-
4	COMMUNICATION	Interface settings (Section 8.4.5)	-
3	PRINT PROTOCOL	Print protocol settings (Section 8.4.6)	-
4	CLOCK	Real time settings (Section 8.4.7)	-
4	FUNCTION KEYS	Function key assignments (Section 8.4.8)	Yes
4	DISPLAY	Setting the Info line 1 and 2 contents, contrast (Section 8.4.9)	-
0	FUNCTION TEST	Test functions DIS2116 (Section 8.4.10)	-
0	MODE	Basic scale functions (Section 8.4.11)	Yes
4	SCALE CONFIGURATION	Segments, load cells (Section 8.4.12)	Yes
4	SCALE PARAMETERS	Basic scale functions (Section 8.4.13)	Yes
5	OFF-CENTER LOAD COMPENSATION	Off-center load error compensation (Section 8.4.14)	Yes
5	FACTORY SETTINGS	Reset to factory settings (Chapter 8.4.15)	Yes

¹⁾ Access only via hidden pushbutton

8.3 Navigation in the parameter menu

The parameter menu has three levels. The first two levels are used for structuring the menu. Parameters are displayed and entered in the third level. All four keys ("F1" ... "F4") are used for navigation in the parameter menu.

8.3.1 Navigation via device keys

Key	Explanation
	Open parameter menu
	Return to higher menu level or exit parameter menu
	Go to sub-menu / change parameter (Enter)
	"F1" ... "F4" depending on the displayed function

Level 1

The selected parameter block is indicated by a black bar. Use the "F2" or "F3" to select the required parameter block.

Use  (Enter) to access the selected sub-menu. The sub-menu is then displayed in Info line 1.

Level 2

Use keys "F2" and "F3" to select the required sub-menu and open it with the  key (Enter). Info line 1 displays the path: Menu 1 → Menu 2, e.g. "COMMUNICATION → LOAD CELLS (COM1)".

Navigate to the required parameter with the keys "F2" and "F3" and confirm your entry with  (Enter).

Level 3





The parameter is displayed and the actual setting indicated with a black bar and a * behind the set value.

Move the black bar with the arrow keys "F2" and "F3" to the new setting and confirm with  (Enter). The setting is applied and the sub-menu exited.

To cancel an entry (without changing the parameter), exit the menu via the  key.

8.3.2 Navigation via external keyboard

The external keyboard is connected to the PS/2 connection (Fig. 5.2: Page 18)

Significance of the keys	
External keyboard (PS/2)	DIS2116 front panel
"F1" to "F4"	"F1" to "F4"
 (Enter)	
ESC	
F5	



The arrow keys can also be used for navigation:







- "F5" key: Open parameter menu
- ↑↓ Select parameter (similar to keys "F2", "F3")
- → Scroll to next level e.g. from level 1 to 2
- ← Scroll back to previous level e.g. from level 2 to 1 (analogous to )

8.4 Full menu structure

The description follows the main menu sequence (for the first level, see Section 8.2 (Page 35)).



8.4.1 Parameter menu “INFORMATION”





Access: Key  , **INFORMATION**  (Enter)

		Sub-menu explanation
INFORMATION		Access level 0
	SCALE 	The scale type plate is displayed.
	TARE VALUE 	The tare value with unit is displayed.
	WEIGHING RESULT 	The last weighing result recorded with Weighing 2 is displayed. The full display contains the following parameters: Vehicle number, goods, process, Weighing1, Weighing2, tare, result, date, time and print No.
	BUS SCAN 	All digital load cells connected to the DIS2116 are displayed in ascending address order. The address, type, serial number, legal-for-trade and overload counters are displayed in one line for each load cell. The header displays, for the selected load cell: Manufacturer, Type, serial number, software version.
	ERROR LIST 	The errors occurred are displayed with the error number, date, time, load cell address and frequency.
	SOFTWARE INFO 	Software version of display with date and time of creation.
	GRAPHIC 	OSCILLOSCOPE: Graphic display of measured values. CENTER OF GRAVITY: Graphic center of gravity display, from 3 load cells upwards.

8.4.2 Parameter menu “PRINT”

The Print function is only accessible if COM3 is activated for printing.







Access: Key , **PRINT**  (Enter)

Sub-menu explanation		
PRINT		Access level 1
	MEASURED VALUE 	Measured value sub-menu (8.4.2.1)
	WEIGHING 1 ¹⁾ 	Automatic printout after Weighing 1
	WEIGHING 2 ¹⁾ 	Automatic printout after Weighing 2
	PARAMETERS 	Sub-menu Print parameters (8.4.2.3)

¹⁾ Only in “VEHICLE” operating mode

8.4.2.1 Parameter menu “PRINT → MEASURED VALUE”







Access: Key , **PRINT**  **MEASURED**  (Enter)

Sub-menu explanation		
PRINT		Access level 1
	MEASURED VALUE	Measured value sub-menu
	None 	No print protocol selected
	Prt01 – MV(Act) 	Print protocol selection. Printing is initiated via key “F1”, when the following symbol is displayed: 
	Prt02 – MV1 	
	Prt03 – MV2 	
	Prt04 – Total 	
	Prt05 – Result 	

The print function is described in Chapter 14 (Page 92).

8.4.2.2 Parameter menu “PRINT → WEIGHING 1/2”



Access: Key , **PRINT**  **WEIGHING 1/2**  (Enter)

		Sub-menu explanation	
PRINT		Access level 1	
	WEIGHING 1/2		Sub-menu Weighing 1/2
	None		No print protocol selected
	Prt01 – MV(Act)		Print protocol selection. Printing is initiated via key “F1”, when the following symbol is displayed: 
	Prt02 – MV1		
	Prt03 – MV2		
	Prt04 – Total		
	Prt05 – Result		

The print function is described in Chapter 14 (Page 92).



8.4.2.3 Parameter menu “PRINT → PARAMETERS”



Access: Key , **PRINT**  **PARAMETERS**  (Enter)

		Sub-menu explanation	
PRINT → PARAMETERS		Access level 1	
	SCALE PARAMETERS		The adjustment parameters of the load cells are printed.
	DIS2116 PARAMETERS		The settings of the DIS2116 display are printed.
	BUS SCAN RESULT		The results of the bus scan are printed.

The print function is described in Chapter 14 (Page 92).



8.4.3 Parameter menu “LIMIT VALUE”

Access: Key , **LIMIT VALUE**  (Enter)

			Sub-menu explanation
LIMIT VALUE			Access level 2
	LIMIT VALUE 1		Limit value 1 setting
	LIMIT VALUE 2		Limit value 2 setting

8.4.3.1 Parameter menu “LIMIT VALUE → LIMIT VALUE 1”

Access: Key , **LIMIT VALUE** , **LIMIT VALUE 1**  (Enter)

			Sub-menu explanation	
LIMIT VALUE → LIMIT VALUE 1			Access level 2	
	INPUT SIGNAL		Selection of the input signal for limit value 1	
			OFF	Limit value 1 is switched off, no monitoring.
			NET*	The net measured value is monitored.
			GROSS	The gross measured value is monitored.
	ACTIVATION LEVEL		The activation level is input as a weight value. If the input signal exceeds the activation level, the symbol for limit value 1 is displayed.	
	DEACTIVATION LEVEL		The deactivation level is input as a weight value. If the input signal undershoots the deactivation level, the limit value 1 symbol disappears.	

* Factory settings

Input activation level > deactivation level

If the selected measured value (gross or net) exceeds the set limit value 1 (2), this is displayed in the status line ( 1,2).

Input deactivation level > activation level



The limit value display ( 1,2) is displayed in the status line until the measured value (gross, net) exceeds the set limit value 1 (2).



8.4.3.2 Parameter menu “LIMIT VALUE → LIMIT VALUE 2”

Access: Key , **LIMIT VALUE**  **LIMIT VALUE 2**  (Enter)

The sequence for setting limit value 2 is identical to that for limit value 1 (Section 8.5.3.1).



8.4.4 Parameter menu “FILTER”



Access: Key , **FILTER**  (Enter)

FILTER		Sub-menu explanation	
FILTER		Access level 4	
FILTER MODE		Selection of filter characteristics	
		FILTER MODE	
		0-IIR2*	Standard filter: IIR 2nd order low-pass filter
		1-FIR32	3 stage fast-settling digital filter (FIR low-pass filter)
		2-IIR8	IIR 8th order low-pass filter
		3-IIR4FT	Fast-settling digital filter (IIR 4th order low-pass filter)
4-FIR64	Fast-settling digital filter (FIR low-pass filter, settling time <100 ms)		
CUT-OFF FREQUENCY		The limit frequency can be set in 11 steps. The appropriate limit frequencies (in Hz) can be found in the descriptions of the connected load cells (C16i, measurement chains; FMD , ASF commands).	

The filter characteristics are described in Chapter 9, Page 64.

8.4.5 Parameter menu “COMMUNICATION”

Access: Key , **COMMUNICATION**  (Enter)

COMMUNICATION		Sub-menu explanation	
		Access level 4	
LOAD CELLS (COM1)		BAUD RATE	9.6K, 19.2K, 38.4K*, 57.6K, 115.2k
		2-WIRE COMM.	OFF: Full duplex (separate transmission/reception line 4-wire) ON*: Half duplex (common transmission/reception line 2-wire)
PC/PLC (COM2)		FUNCTION	OFF* Interface is inactive ON Interface is active
		BAUD RATE	Baud rate setting for processor communication: 1.2K, 2.4K, 4.8K, 9.6K*, 19.2K, 38.4K, 57.6K, 115.2K
		PARITY	NONE*, EVEN, ODD
PRINTER (COM3)		FUNCTION	OFF Interface is inactive ON* Serial interface (RS-232) is active USB ON USB interface is active
		BAUD RATE (RS-232)	1.2K ... 115.2K
		PARITY (RS-232)	NONE*, EVEN, ODD

* Factory settings

Parameter menu "COMMUNICATION" (continued)

			PROTOCOL (RS-232)	DTR* Hardware handshake DC1 Software handshake
	EXT. DISPLAY (COM4)		FUNCTION	OFF* Interface is inactive String 1 String 2 see Chapter 15 String 3 String 4 String 5
STANDARD DISPLAY ¹⁾			- None microSYST MIGRA (numerical display) microSYST MIGAN (graphical display)	
PROTOCOL			OFF* No handshake DTR Hardware handshake DC1 Software handshake	
BAUD RATE			1.2K ... 115.2K	
PARITY			NONE*, EVEN, ODD	
START STRING LENGTH			0* = No start string 1 ... 15 = Number of characters for start string	
Character 1 ... Character 15			Input of any ASCII character as decimal value, when START STRING LENGTH > 0	

* Factory settings

¹⁾ When connecting and selecting a standard display, the interface COM4 is automatically configured, no further settings are required under EXT. display (COM4). For specifications for the standard displays, please refer to the manufacturer's documentation.

Parameter menu "COMMUNICATION" (continued)

			END STRING LENGTH	0* = No end string 1...5 = Number of characters for end string
			Character 1 ... Character 5	Input of any ASCII character as decimal value, when END STRING LENGTH > 0
			CRC	OFF No checksum ON* Checksum
			DECIMAL POINT	POINT* COMMA OFF No decimal point
			PAUSE [10ms]	Time until display string is repeated
			MEASURED VALUE LENGTH	Number of measured value digits that can be displayed Standard (9 digits) 2 ... 9 digits for the measured value

* Factory settings

8.4.6 Parameter menu “PRINT PROTOCOL”

Access: Key **PAR**, **PRINT PROTOCOL** (Enter)

PRINT PROTOCOL		Sub-menu explanation	
		Access level 3	
	PRINTOUT NUMBER	←	Consecutive number of printout
	USER-DEFINED LINE 1	←	A maximum of 32 text characters can be entered for printout in line 1.
	USER-DEFINED LINE 2	←	A maximum of 32 text characters can be entered for printout in line 2.
	USER-DEFINED LINE 3	←	A maximum of 32 text characters can be entered for printout in line 3.
	BLANK LINES ABOVE	←	0 to 99 blank lines above the printout of USER DEFINED LINE 1
	BLANK LINES BELOW	←	0 to 99 blank lines below the printout
	SPACES	←	0 to 99 spaces
	PAGE FEED	←	OFF* After printing, no page feed is performed. ON Page feed after printout
	ESCAPE1 (CHAR. 1) to ESCAPE1 (CHAR. 5)	←	Input of an ESCAPE sequence that consists of maximum 5 characters. The characters are entered as ASCII characters with their decimal value.
	ESCAPE2 (CHAR. 1) to ESCAPE2 (CHAR. 5)	←	Input of an ESCAPE sequence that consists of maximum 5 characters. The characters are entered as ASCII characters with their decimal value.



* Factory settings



2 ESCAPE sequences can be entered with ESCAPE1 and ESCAPE2. Each ESCAPE sequence consists of maximum 5 characters.

8.4.7 Parameter menu “CLOCK”

The date consists of xx.yy.zz (DAY/MONTH/YEAR). When entering the DAY or MONTH, inputs of 01 to 31 and 01 to 12 are permissible. If a number combination outside 01 to 31 and 01 to 12 is entered, the previous value is displayed again and the dialog is not exited. DAY, MONTH and YEAR must always be entered with 2 digits.

The 24 hour or 12 hour mode can be selected for the time display.

Access: Key , **CLOCK**  (Enter)



CLOCK		Sub-menu explanation		
		Access level 4		
DATE		DAY	The DAY is a 2 digit entry from 01 to 31	
		MONTH	The month is a 2 digit entry from 01 to 12	
		YEAR	The year is a 2 digit entry from 00 to 99	
	TIME		MODE	24h 24 hour mode 12h 12 hour mode
			AUTOMAT. DAYLIGHT SAVING TIME	OFF* ON activates automatic time adjustment; summertime from the last Sunday in March, wintertime from the last Sunday in October
			MINUTES	Input 00 ... 59 minutes
HOURS			In 24h mode: 00 ... 23 In 12h mode: 00 ... 12 toggle AM/PM with “F1”	







* Factory settings

8.4.8 Parameter menu “FUNCTION KEYS”

The meaning of the FUNCTION KEYS is displayed in the function line. The function line is changed with “F4”.

The applicable functions are enabled/disabled in the Function keys menu.

Access: Key , **FUNCTION KEYS**  (Enter)

FUNCTION KEYS		Sub-menu explanation	
		Access level 4	
ZEROING		INACTIVE	The zeroing function is not available in measuring mode
		ACTIVE*	In measuring mode, the function key “F3” (level 3) is assigned with the zeroing function (>0<)
TARING		INACTIVE	The taring function is not available in measuring mode
		ACTIVE*	In measuring mode, the function key “F3” (level 2) is assigned with the taring function (>T<)
GROSS/NET		INACTIVE	The GROSS/NET selection function is not available in measuring mode
		ACTIVE*	In measuring mode, the function key “F2” (level 2) is assigned with the Gross/Net function
10-FOLD RESOLUTION		INACTIVE*	The 10-fold resolution function is not available in measuring mode
		ACTIVE	In measuring mode, function key “F2” (level 3) is assigned with the 10-fold (x10) resolution function
PRINT		INACTIVE*	The print function is not available in measuring mode
		ACTIVE	In measuring mode, the function key “F2” (level 3) is assigned with the print function: 

* Factory settings

8.4.9 Parameter menu “DISPLAY”



The contents of information lines 1 and 2 are specified, and the display contrast is set in the DISPLAY menu.



The information lines 1 and 2 are divided into 2 sections each, so that you can freely assigned the listed display content options for the information lines. A maximum of four information items can be displayed.

The following information is available:

- **—** : Nothing is displayed in the selected section
- Scale ID: Manufacturer, Type, serial number and software version.
To display this information in full, both halves (left and right) of the information line are required.
Left side of information line: Manufacturer and type
Right side of information line: Serial number and software version
- Weighing 1 Measured value of first measurement (input scale)
- Weighing 2 Measured value of second measurement (output scale)
- Total Weighing result weighing2 – weighing1
- TCR LFT counter displays number of verification procedures
- TRUCK Vehicle number plate
- GOODS Description of goods
- PROCESS Designation of process
- TARE The actual tared weight is displayed
- TARE PT A manually entered tare value (Manual tare/Pre-tare)
- Date/Time Actual date with time

Select the required entry with keys “F2”, “F3” and apply with .



Access: Key , **DISPLAY**  (Enter)



Sub-menu explanation				
DISPLAY			Access level 4	
	DISPLAY LINE 1		LEFT	Display in left half of information line 1
			RIGHT	Display in right half of information line 1
	DISPLAY LINE 2		LEFT	Display in left half of information line 2
			RIGHT	Display in right half of information line 2
	CONTRAST		-10* ... 0 ... +10	The contrast can be adjusted in 21 steps from -10 to +10.

* Factory settings







8.4.10 Parameter menu “FUNCTION TEST”

In the FUNCTION TEST menu, the function of the interfaces, display, keys and the SD card can be checked.

Access: Key , **FUNCTION TEST**  (Enter)

FUNCTION TEST		Sub-menu explanation	
		Access level 4	
	BUS SCAN 	A search is made for all digital load cells connected to COM1. All the digital load cells found are displayed with their address, serial number, legal-for-trade counter status and overload counter status. A load cell can be selected with keys “F2” , “F3”. The line above the table displays the manufacturer, type, serial number and software version of the selected load cell.	
	LOAD CELL 	LOAD CELL ADDRESS	Enter the address of the load cell to be checked.
		MEASURED VALUE	The measured value of the selected load cell is displayed in internal digits. If a non-existent address is selected, 9 star symbols are displayed instead of the measured value.
SEGMENT 	LOAD CELL TEST	Checking the selected load cell.	
	SEGMENT NUMBER	Enter the number 1 to 3 of the segment to be checked.	
	MEASURED VALUE	The measured values of all load cells in the selected segment, and the total measured value, are displayed in weight units. Only segments that are present can be selected.	

Parameter menu "FUNCTION TEST" (continued)



	COM1		COM1 Test	At COM1 (load cell interface) the capital letter U (0x55) is permanently output. If the transmission outputs TB and TA are connected to the inputs RB and RA, the transmitted character is received again and displayed. In COM1 Test, the number of transmitted and received characters are displayed. No load cells must be connected at the interface when checking COM1.
	COM2		COM2 Test	The capital letter U (0x55) is permanently output at the selected interfaces COM2 (PC/PLC), COM3 (printer) and COM4 (second display). If the transmission output Tx is connected to the reception input Rx, the sent character is received again and displayed. The number of transmitted and/or received characters is displayed.
	COM3		COM3 test	
	COM4		COM4 test	
	SD CARD		SD test	The internal memory card is checked and the free memory displayed in bytes.
	DISPLAY			Various patterns are displayed in the display field for the display test.
	KEYS		Key test	The corresponding key code is displayed if the key is recognized when a key is pressed. The exception is the "CE" key, as pressing the "CE" key ends the KEY test.

8.4.11 Parameter menu “MODE”

The following functions are set in the MODE menu:

- LANGUAGE (see following table for explanation)
- ACCESS LEVEL
The ACCESS LEVEL menu is used to specify which menus are still accessible to the user (see right column in following table). If the DIS2116 is verified, the access levels can only be changed via the hidden pushbutton. The access levels can be set in 5 levels.
- LEGAL-FOR-TRADE CAPABILITY (see following table for explanation)
Weights and measures regulation and class settings. If the DIS 2116 has been set to OIML or NTEP, this setting can only be cancelled via the hidden key.
- ENCRYPTION (see following table for explanation)
- OPERATING MODE (see following table for explanation)
- PASSCODE PROTECTION (as of firmware P105)
After activation and entry of a passcode, access to LFT parameters is protected by the passcode (parameter menus “FUNCTION KEYS”, “MODE”, “SCALE CONFIGURATION”, “SCALE PARAMETERS”, “OFF-CENTER LOAD COMPENSATION” and “FACTORY SETTINGS”).



i **IMPORTANT** *If the passcode is lost, parameters cannot be edited and the DIS2116 must be reset by HBM Service.*

Access: Key , **MODE**  (Enter)

MODE		Sub-menu explanation		
		Access level 0		
	LANGUAGE		ENGLISH	Menu texts and dialog in English
			DEUTSCH*	Menu texts and dialog in German
			РУССКИЙ	Menu texts and dialog in Russian
			FRANCAIS	Menu texts and dialog in French
			ITALIANO	Menu texts and dialog in Italian
			ESPANOL	Menu texts and dialog in Spanish
			CATALA	Menu texts and dialog in Catalan
			PORTUGUES	Menu texts and dialog in Portuguese



* Factory settings

Parameter menu "MODE" (continued)

	ACCESS LEVEL		0	Enabled menus: INFORMATION FUNCTION TEST MODE
			1	Enabled menus: INFORMATION PRINT FUNCTION TEST MODE
			2	Enabled menus: INFORMATION PRINT LIMIT VALUE FUNCTION TEST MODE
			3	Enabled menus: INFORMATION PRINT LIMIT VALUE PRINTER FUNCTION TEST MODE
			4	INFORMATION PRINT LIMIT VALUE FILTER COMMUNICATION PRINTER CLOCK FUNCTION KEYS DISPLAY FUNCTION TEST MODE
			5*	All menus are accessible
	LEGAL-FOR-TRADE CAPABILITY		NO*	Not verified
			OIML III	
			OIML IIII	Ordinary accuracy weighing machines up to 1000 d
			NTEP III	
			NTEP IIII	US Truck scales up to 10 000 d





* Factory settings

Parameter menu "MODE" (continued)

	ENCRYPTION		OFF*	The measured values are transmitted unencrypted.
			ON	The measured values are transmitted encrypted. In verified operation, this setting can only be changed via the hidden key.
	OPERATING MODE		Standard*	
			Vehicle	See Chapter 13, Vehicle scales.
	PASSCODE PROTECTION			Activation of passcode protection and input of passcode. The passcode must be entered twice to avoid input errors.

8.4.12 Parameter menu “SCALE CONFIGURATION”

Access: Key , **SCALE CONFIGURATION**  (Enter)

SCALE CONFIGURATION		Sub-menu explanation	
		Access level 4	
SEGMENT NUMBER		1 segment*	Segment selection Segment 1 can contain up to 12 load cells, segments 2 and 3 up to 8
		2 segments	
		3 segments	
SEGMENT 1		NUMBER OF LOAD CELLS	Number of load cells used in segment 1. Selection: 1*, 3, 4, 6, 8, 10, 12
		SERIAL NUMBER LC11 to LC20 and LC41/LC42	The load cell serial number must be entered for the selected load cell. The load cell with this serial number is assigned the applicable address. <i>Example: Serial number LC11: 102345. The load cell with the serial number 102345 is assigned the address 11</i>
SEGMENT 2		NUMBER OF LOAD CELLS	Number of load cells used in segment 2. Selection: 1*, 3, 4, 6, 8
		SERIAL NUMBER LC21 to LC28	Inputs as in Segment 1 <i>Example: Serial number LC21: 102345. The load cell with the serial number 102345 is assigned the address 21</i>
SEGMENT 3		NUMBER OF LOAD CELLS	Number of load cells used in segment 3. Selection: 1*, 3, 4, 6, 8
		SERIAL NUMBER LC31 to LC38	Inputs as in Segment 1 <i>Example: Serial number LC31: 102345. The load cell with the serial number 102345 is assigned the address 31</i>
CONFIGURATION			

* Factory settings

8.4.13 Parameter menu “SCALE PARAMETERS”

The following functions are set in the “SCALE PARAMETERS → PARAMETERS” menu:

- **MANUFACTURER** (see following table for explanation)
- **IDENTIFICATION** (see following table for explanation)
- **LOAD CELL SAMPLING RATE** (see following table for explanation)
- **UNIT** (see following table for explanation)
The unit is displayed with the measured value and is also used for standstill checking. Visible unit of measurement means standstill.

- **DECIMAL POINT**

x = no decimal place
x.x = one decimal place
x.xx = two decimal places, etc.

- **RESOLUTION**

Increment input. The value determines the resolution of the last place(s).

Example: Nominal value 50.00 kg = 5000 d
Resolution 1d → Total resolution 5000 d
Resolution 2d → Total resolution 2500 d
Resolution 5d → Total resolution 1000 d

In multi-range scales, the increment is automatically increased when switching to the next range. The resolution for the first range must be entered.

Example: 3-range scale, set resolution 1 d
Weight < MR 1 → Resolution 1 d
MR 1 < Weight < MR 2 Resolution 2 d
Weight > MR 2 → Resolution 5 d
MR = Multi-range

The settings made are also entered into the electronic type plate (Menu “INFORMATION → SCALE”).

- **NOMINAL VALUE**

The nominal (rated) value must be entered numerically correctly with all places.

Example: 50 kg with 5000 division resolution entry: 50.00 kg

- **LOAD CELL NOMINAL VALUE**

The nominal value must be entered numerically correctly with all places as in NOMINAL VALUE.

If the load cell maximum capacity different to the scale maximum capacity, you must enter the maximum capacity of the individual load cells here. The setting is required for the digital off-center load compensation.

- **MULTIRANGE 1**

The measuring range is displayed with measured value status.

Example: 100.00 kg scale; MULTIRANGE 1: 50.00 kg
0 ... 50 kg measuring range 1, resolution 10 g >|1|<
50 ... 100 kg measuring range 2, resolution 20 g >|2|<

- **MULTIRANGE 2**

The measuring range is displayed with measured value status.

Example: 100.00 kg scale, MULTIRANGE 1: 50.00 kg; MULTIRANGE 2: 80.00 kg
0 ... 50 kg measuring range 1, resolution 10 g >|1|<
50 ... 80 kg measuring range 2, resolution 20 g >|2|<
8 ... 100 kg measuring range 3, resolution 50 g >|3|<

- ZERO TRACKING

The automatic zero tracking occurs for a gross or net measured value $< 0.5d$ in the range $+2\%$ of the nominal value of the scale. The maximum reset speed is 0.5 d/s when the scale is at standstill. Standstill recognition can be set in the parameter Standstill monitoring. The unit d (digit) is equal to one verified scale division e .

- ZERO ON START-UP

Zero on start-up means that, when the scale is switched on, a weight up to max. $+20\%$ of the nominal (rated) value is set once to zero. In legal-for-trade applications, a max. of $+10\%$ of the nominal value can be set to zero. Zero setting is only implemented at a standstill and when the weight is within the specified range. Possible settings are OFF, $+2\%$, $+5\%$, $+10\%$ and $+20\%$ of the nominal value.

- STANDSTILL MONITORING

Standstill check. Standstill means that the weight does not change by more than the set value in one second. Standstill is indicated by the unit of measurement. If the standstill condition is not met, the unit of measurement is not displayed. The setting 1 d/s applies for a verified scale.

The following settings are possible:

- OFF: Standstill monitoring is disabled, the display is always in the standstill mode, the unit of measurement is permanently displayed.
- 0.25 d/s : Standstill is when the weight value does not change in one second by more than $0.25d$.
- 0.5 d/s : Standstill is when the weight value does not change in one second by more than $0.5d$.
- 1 d/s : Standstill is when the weight value does not change in one second by more than $1d$.
- 2 d/s : Standstill is when the weight value does not change in one second by more than $2d$.
- 3 d/s : Standstill is when the weight value does not change in one second by more than $3d$.

Example: If a resolution of $1g$ and standstill monitoring of 1 d/s is set, the standstill condition is met when the weight value does not change by more than $1g/s$.

- G FACTOR CALIBRATION /APPLICATION

The g-factor setting is only required when the scale is calibrated at the production site and operated at another place with this setting. If the scale is calibrated at the installation site, both g-factors must be identical.

- MANUAL TARE MODE/VALUE

Input of a known TARE value. The input TARE value is displayed as a manual tare value with the symbol PT in the display. The display [Tare PT] must be activated for this in the "DISPLAY→DISPLAY → DISPLAY LINE 1(2)".





Access: Key , **SCALE PARAMETERS**  (Enter)

Sub-menu explanation			
SCALE PARAMETERS		Access level 4	
PARAMETER		MANUFACTURER	Enter a manufacturer ID with max. 3 letters. This designation can be found in the scale ID.
		IDENTIFICATION	Enter a type designation or name with max. 15 characters. This designation can be found in the scale ID.
		LOAD CELL SAMPLING RATE	Standard* High speed ¹⁾
		UNIT	Enter a unit of mass with max. 4 letters.
		DECIMAL POINT	Enter the number of decimal places.
		RESOLUTION	1d*; 2d; 5d; 10d; 20d; 50d; 100d
		NOMINAL VALUE	Enter the maximum scale capacity. The decimal point and unit must be set beforehand.
		LOAD CELL NOMINAL VALUE	Input the load cell maximum capacity when this is different from the maximum scale capacity
		MULTIRANGE 1	Changeover point from measuring range 1 to measuring range 2.
		MULTIRANGE 2	Changeover point from measuring range 2 to measuring range 3.
		ZERO TRACKING	OFF* ON
		ZERO ON START-UP	OFF* 2% 5% 10% 20%



* Factory settings

¹⁾ The actual data rates in measurements/sec can be found in the documentation of the load cells used (measuring chains).

Parameter menu "SCALE PARAMETERS" (continued)

			STANDSTILL MONITORING	OFF* 0.25 d 0.5 d 1 d 2 d 3 d
			G FACTOR CALIBRATION	Enter g (gravitational acceleration) at calibration location, e.g. 98104
			G FACTOR APPLICATION	Enter g (gravitational acceleration) at calibration location, e.g. 98109
			MANUAL TARE MODE	OFF* ON
	CHARACT. CURVE ENTRY		ZERO LOAD	Enter the value for the unloaded scale in internal digits.
			MAXIMUM CAPACITY	Enter the value for the scale loaded with the maximum capacity.
	CHARACT. CURVE MEASUREMENT		CALIBRATION WEIGHT	The calibration weight is entered in weight units. It should be min. 20% and max. 120% of the maximum scale capacity. An adjustment with 5% of the maximum scale capacity is also possible for non-verifiable scales. Please note: The smaller the balancing weight is, the greater the full scale error.
			ZERO LOAD	The measured value for the unloaded scale is displayed in internal digits. When the display is settled, the value is applied with  and the dialog exited.
			MAXIMUM CAPACITY	The measured value for the scale loaded with the calibration weight is displayed in internal digits. When the display is settled, the value is applied with  and the dialog exited.

Parameter menu "SCALE PARAMETERS" (continued)

	LINEARIZATION		WEIGHT 1	see Chapter 11
			MEASURED VALUE 1	
			MEASURED VALUE 1 ENTRY	
			WEIGHT 2	
			MEASURED VALUE 2	
			MEASURED VALUE 2 ENTRY	
	LOAD CELL REPLACEMENT		LOAD CELL ADDRESS	Enter the address of the load cell to be replaced.
			NEW SERIAL NUMBER	Serial number of the new load cell.
			UPLOAD PARAMETER	Initialization of the new load cell with the parameters of the replaced load cell.



The parameters of the defective load cell are transferred to the new load cell. After a defective load cell is replaced, a new adjustment is not necessary, but the new load cell must be installed in the same manner as the replaced cell.



8.4.14 Parameter menu “OFF-CENTER LOAD COMPENSATION”

The scale is loaded at different points with a weight 20% (5%) to 120% of the maximum capacity. Once this procedure is complete, the off-center load error is compensated and the scale adjusted.

There are three methods for compensation of off-center load error:

Example: Method for off-center load error compensation for a scale with 4 load cells (addresses 11...13)

Access: Key , **OFF-CENTER LOAD**  (Enter)



Sub-menu explanation			
OFF-CENTER LOAD COMPENSATION		Access level 5	
	MEASURE 	MODE	SIMPLE AVERAGE PRECISE
		CALIBRATION WEIGHT	Weight with which the off-center load compensation is implemented.
		SEGMENT 1	Segment in which the off-center load compensation is implemented. The steps are explained in the Chapter Off-center load compensation.
	INPUT SEGMENT 1 	CORRECTION VALUE	Numerical input

The procedure for digital OFF-CENTER LOAD COMPENSATION is described in detail from Section 10.7 onwards.

The entry of a correction value is described in Section 10.7.4, Page 79.







8.4.15 Parameter menu “FACTORY SETTINGS”

Access: Key , **FACTORY SETTINGS**  (Enter)

FACTORY SETTINGS		Sub-menu explanation	
		Access level 5	
	DIS2116		Factory settings? ¹⁾ YES NO You are asked again Factory settings? YES (“F2”) The factory settings are restored, all data reset to factory settings. NO (“F3”) The Restore factory settings function is cancelled.
	LOAD CELLS		Reset load cells? YES NO You are asked again Reset load cells? YES (“F2”) The factory settings are restored in all load cells connected to the DIS2116. NO (“F3”) The Restore factory settings function is cancelled.

¹⁾ For the settings used when restoring to factory settings, see Chapter 19, Page 111.

Parameter menu "FACTORY SETTINGS" (continued)

			DELETE YARD LIST		You are asked again "DELETE YARD LIST?" "YES" ("F2") All vehicles will be deleted from the yard list (list of accepted vehicles). NO ("F3") The dialog is exited without deleting the yard list.
	DATABASE		DATABASE REPAIR		You are asked again "START REPAIR?" YES ("F2") The database entry list is restored. NO ("F3") The dialog is exited. The function will not be carried out.
			DATABASE TITLE 1/2/3		Enter text for the column headers in the database.

9 Filter selection

The DIS2116 has five different filters. These can be selected via the parameter menu “FILTER → FILTER MODE”:

- Standard filter (IIR low-pass filter)
- Fast-settling digital filter (FIR low-pass filter)
- IIR 8th order low-pass filter
- Fast-settling digital filter (IIR 4th order low-pass filter)
- Fast-settling digital filter (FIR low-pass filter)

The filter cut-off frequency is adjustable in 10 steps (0 ... 9). The settings are made in the parameter menu “FILTER- → LIMIT FREQUENCY”. Setting 0 means that the filter is disabled.

The particular application determines which filter mode is selected.

A low bandwidth has a longer settling time and should be selected for greater accuracy.

Scale resolution (“NOMINAL VALUE” parameter) and standstill recognition are interlinked. If standstill is not achieved, the filter bandwidth must be reduced.



IMPORTANT *The filters are a component of the load cells. Their properties are described in the documentation of the load cells (C16i, measurement chains) (commands **FMD**, **ASF**, **HSM**).*

10 Scale adjustment

The scale is adjusted by setting the user characteristic curve on the DIS2116, that is to say, the weighing electronics adapt to the actual output signals that the digital load cell(s) supplies when the scale(s) is not loaded or at nominal weight. Calibration weights are usually required for this, another alternative is to input the measured values, if these are known.

The adjustment range depends on the maximum capacity of the load cells used. The factory setting is a resolution of 10000d for the maximum capacity of the scale, adjusted (factory settings, see Section 8.4.15 (Page 62)).

Three methods are available to adjust a scale:

1. Scale adjustment by measuring the characteristic curve
This method is described in Sections 10.3 to 10.5.
2. Computational scale adjustment
This method is described in Section 10.6.
3. Scale adjustment with digital off-center load compensation
From a scale configuration with minimum 4 load cells, the scale adjustment can also be implemented with digital off-center load compensation. This method is described in Section 10.7.

10.1 Configuration of the load cells

During initial commissioning, all digital load cells have the same address (31), a measured value display is not possible. This is why an initialization error is shown in the display [INIT ERROR].

Each load cell must be assigned its own address. This is possible with the aid of the load cell serial number.

Proceed as follows:

- Call the parameter menu via the hidden pushbutton.
- To set the address, enter the parameter menu "SCALE CONFIGURATION".

The addresses for the load cells must be assigned for each segment increasing clockwise (e.g. in segment 1, start in one corner with the address 11). See Section 10.2 on Page 66.



TIP

If the load cells have already been assigned individual addresses (e.g. with the AED Panel32 program), measured values are displayed after switching on and you can start directly with scale adjustment.

10.2 Structure of a scale segment

In the scale segment structure, the load cells must be arranged clockwise according to their bus address. The bus addresses are automatically assigned during scale configuration. As the first number usually designates the segment and the second the load cell, this results in numbers between 11 and maximum 20 for 4, 6, 8 or 10 load cells (see Fig. 10.1 to Fig. 10.4) in the first segment. The numbers 21 to 28 apply in the second segment with 8 load cells, and 31 to 38 in the third segment. If there are 12 load cells in the first segment, the numbers 41 and 42 are also used (Fig. 10.5). Configuration with 10 or 12 load cells is only possible as of firmware P105.



Fig. 10.1: Scale segment with 4 load cells in first segment

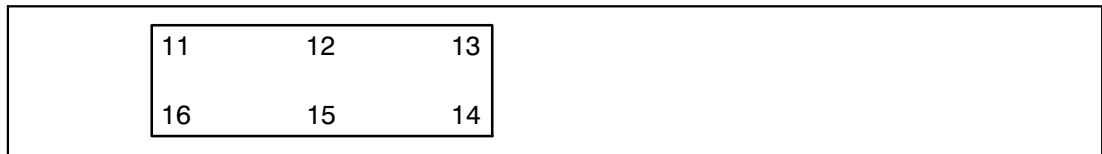

Fig. 10.2: Scale segment with 6 load cells in first segment

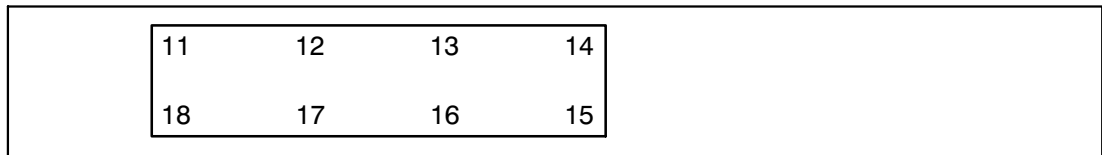

Fig. 10.3: Scale segment with 8 load cells in first segment

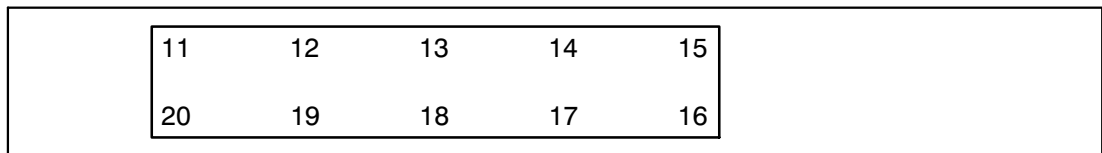

Fig. 10.4: Scale segment with 10 load cells (only possible in segment 1 and as of firmware P105)

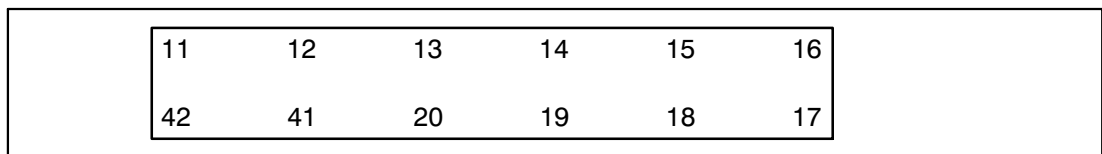

Fig. 10.5: Scale segment with 12 load cells (only possible in segment 1 and as of firmware P105)



TIP

Use the left or right arrow keys to display the currently hidden load cells during an off-center load compensation of a scale segment with more than 8 load cells.

10.3 Prerequisites for scale adjustment

Before the scale can be adjusted, the nominal range of the scale and other parameters must be set.

The prerequisites here are:

- The parameter menu is called via the hidden switch.
- Parameter menu "MODE → ACCESS LEVEL" = "5" (access to all menus).
- Parameter menu "MODE → LFT CAPABILITY" = "NO" (LFT application disabled).
- Set parameter menu "SCALE PARAMETERS → PARAMETERS → UNIT-DECIMAL POINT-NOMINAL VALUE-RESOLUTION".
- Set parameter menu "SCALE PARAMETERS → PARAMETER → G-FACTOR CALIBRAT." to the gravitational acceleration value of the adjustment location.
- Parameter menu "SCALE PARAMETERS → PARAMETER → G-FACTOR APPLICATION" = "G-FACTOR CALIBRAT." (disable gravitational acceleration correction).
- Switch off linearization: Parameter menu "SCALE PARAMETERS → LINEARIZATION": "WEIGHT1" = "WEIGHT2" = "MEASURED VALUE1" = "MEASURED VALUE2" = "0"

See Section 8.4.11 (Page 52) and Section 8.4.13 (Page 56).

10.4 Scale adjustment with maximum capacity (standard method, calibration weight = nominal (rated) value)

In most scale applications, the adjustment is made at two points, that is to say, when the scale is not loaded and when a calibration weight is placed on it. Calibration is carried out as follows:

1. Call the "SCALE PARAMETERS" parameter menu.
2. Check that the calibration weight is the same as the maximum capacity (calibration weight = nominal (rated) value).
3. Go to the "CHARACTERISTIC CURVE MEASUREMENT" (measurement) sub-menu.
4. Zero value:
 - Relieve the scale.
 - Call the "ZERO LOAD" sub-menu.
 - The actual measured value is displayed with 10-fold resolution (the displayed value is e.g. dependent on the number of load cells).
 - Wait for a steady measurement display.
 - Press the "ENTER" key to store the value.
5. Calibration weight:
 - Place the calibration weight (= maximum capacity of scale) onto the scale.
 - Call the "MAXIMUM CAPACITY" sub-menu.
 - The actual measured value is displayed with 10-fold resolution.
 - Wait for a steady measurement display.
 - Press the "ENTER" key to store the value.

Use the "CE" key to cancel at any time. This will reset the parameter that has just been called (and this one only!) to its former value. The former value is only deleted after storing.

The two values are stored internally at high resolution (internal digits).

If the measured value display is too unsteady, reduce the filter bandwidth (Chapter 9, Page 64). Then set the other parameters.

10.5 Scale adjustment with partial load (calibration weight = 20% (5%) ... 120 % nominal value)

If there is no calibration weight equal to the maximum capacity of the scale, a partial calibration can be performed. To do this, the "CALIBRATION WEIGHT" parameter must be set to the value of the calibration weight used. This must be in the range 5% ... 120 % of the maximum capacity of the scale. In legal-for-trade applications, the adjustment should be carried out with a calibration weight of at least 20% of the maximum capacity of the scale. The calibration weight is scaled like the display value, e.g. 2kg = 2.000, with 3 decimal places.

Until a calibration has been performed, the calibration weight is the same as the nominal (rated) value.



IMPORTANT Before calibration, the parameter "SCALE PARAMETERS → PARAMETERS → NOMINAL VALUE" must be set to the maximum capacity of the scale!

Calibration is carried out as follows:

1. Call the "SCALE PARAMETERS" parameter menu.
2. Go to the "CHARACTERISTIC CURVE MEASUREMENT" (measurement) sub-menu.
3. Set the calibration weight ("CALIBRATION WEIGHT")
4. Zero value:
 - Relieve the scale.
 - Call the "ZERO LOAD" sub-menu.
 - The actual measured value is displayed with 10-fold resolution (the displayed value is e.g. dependent on the number of load cells).
 - Wait for a steady measurement display.
 - Press the "ENTER" key to store the value.
5. Calibration weight:
 - Place the calibration weight (= "CALIBRATION WEIGHT") onto the scale.
 - Call the "MAXIMUM CAPACITY" sub-menu.
 - The actual measured value is displayed with 10-fold resolution.
 - Wait for a steady measurement display.
 - Press the "ENTER" key to store the value.

Use the "CE" key to cancel at any time. This will reset the parameter that has just been called (and this one only!) to its former value. The former value is only deleted after storing.

The two values are stored internally at high resolution (internal digits).

If the measured value display is too unsteady, reduce the filter bandwidth (Chapter 9, Page 64).

Then set the other parameters.

10.6 Adjustment without calibration weight (computational adjustment)

If the scale is designed for very high maximum capacities or if there is no calibration weight available, an adjustment can also be performed by entering the calculated values.

In order to carry out these settings, the display must be changed so that the value measured by the load cells is displayed in digits and not converted into a physical unit, e.g. kg. The digital load cells (e.g. C16i) connected to the DIS2116 are calibrated at the factory to output a measured value of 1000000 (digits) at maximum capacity (load cell maximum capacity) (load cell sensitivity). The characteristic curve can therefore be determined from the known nominal value of the load cells. The zero value is measured.

Requirements:

- All load cells connected to a scale must have the same maximum capacity.
- Off-center load compensation must be switched off (parameter menu "OFF-CENTER LOAD COMPENSATION → MEASURE → SEGMENT 1(2,3)", see Section 8.4.14, Page 61.
- The scale characteristic curve (conversion into physical unit) must be switched off.
To do this, set the following parameters:
 - "SCALE PARAMETERS → PARAMETER → DECIMAL POINT" = "x"
 - "SCALE PARAMETERS → PARAMETER → RESOLUTION" = "1d"
 - "SCALE PARAMETERS → PARAMETER → NOMINAL (RATED) VALUE" = "1000000"
 - "SCALE PARAMETERS → CHARACTERISTIC CURVE ENTRY → ZERO LOAD" = "0" (d)
 - "SCALE PARAMETERS → CHARACTERISTIC CURVE ENTRY → MAXIMUM CAPACITY" = "1000000" (d)

Procedure:

1. Measuring the zero value of the characteristic curve when the scale is not loaded
2. Calculating the nominal value of the scale
3. Entering the characteristic curve
4. Restoring conversion into physical unit

1. Measuring the zero value of the characteristic curve when the scale is not loaded

- Call the "SCALE PARAMETERS" parameter menu.
- Go to the "CHARACTERISTIC CURVE MEASUREMENT" sub-menu.
- Measure zero value:
 - Relieve the scale.
 - Call the "ZERO LOAD" sub-menu.
 - The actual measured value is displayed with 10-fold resolution (the displayed value is e.g. dependent on the number of load cells).
 - Wait for a steady measurement display.
 - Press the "ENTER" key to store the value.
- Make a note of the measured value (mw0) for later input.

2. Calculating the nominal value of the scale

The digital load cells (e.g. C16i) connected to the DIS2116 are calibrated at the factory to output a measured value of 1000000 (digits) at maximum capacity. The nominal value of the scale characteristic curve is composed of the zero value and the weighing range (scale maximum capacity). As the zero value has already been measured, it only remains to define the weighing range.

$$\text{Weighing rang} = \text{Load cell sensitivity [in digits]} \cdot \frac{\text{Maximum capacity of the scale}}{\text{Maximum load cell capacity}}$$

The load cell sensitivity is 1000000 at the load cell maximum capacity. The maximum load cell capacity is stated on the load cell identification plate.

Example: A scale comprises 4 load cells with a load cell maximum capacity of 60t, the scale maximum capacity must be 100t. The weighing range is therefore 1666666.7.

3. Entering the characteristic curve

If you add the value for the weighing range to the previously measured zero value (mw0), you obtain the nominal (rated) value of the scale (mv1). You can then use this to enter the characteristic curve:

- Call the “SCALE PARAMETERS” parameter menu.
- Go to the “CHARACTERISTIC CURVE INPUT” sub-menu.
- Call the “ZERO LOAD” menu and enter the measured value for unloaded scale (mw0).
- Call the “MAXIMUM CAPACITY” menu and enter the nominal value (mw1).

4. Restoring conversion into physical unit

Call the following parameter menus and set the settings for your scale:

- “SCALE PARAMETERS → PARAMETER → DECIMAL POINT”
- “SCALE PARAMETERS → PARAMETER → RESOLUTION”
- “SCALE PARAMETERS → PARAMETER → NOMINAL (RATED) VALUE”

Scales with several load cells supply the nominal (rated) value when the weight equivalent to the maximum scale capacity is applied.



IMPORTANT *Adjustment in digits does not achieve the same accuracy as adjustment with calibration weights and must therefore only be used for applications which require less accuracy.*

10.7 Adjustment with digital off-center load compensation

In this adjustment variant, both the characteristic curve is determined and the off-center load error compensated. A scale configuration with at least 4 load cells is required for digital off-center load compensation.

An adjustment with off-center load compensation is only successful when the load cells in the individual segments are arranged with clockwise ascending addresses (see Section 10.2, Page 66, Scale segment structure).

Requirements:

- The configuration of the load cells must already be implemented as described in Section 10.1.
- The requirements for the adjustment of the scale as described in Section 10.3 must be met.

Procedure:

1. Call the parameter menu "OFF-CENTER LOAD COMPENSATION".
2. Call the "MEASURE" menu.
3. In the menu "MODE", select an adjustment variant: "SIMPLE" – "AVERAGE" – "PRECISE".
4. In the menu "CALIBRATION WEIGHT", enter the weight value used for adjustment. The calibration weight is entered as the weight in weight units with which the off-center load compensation is implemented. The balancing weight should be min. 20% and max. 120% of the scale maximum capacity. An adjustment of up to 5% of the scale maximum capacity is also possible for non-verifiable scales.
Please note: The smaller the balancing weight is, the greater the full scale error.
5. In SEGMENT 1, measure the weight values as specified and accept with "F1". If the scale consists of more than one segment, the adjustment procedure for segments 2 and 3 is identical to that for segment 1.

There are three adjustment modes for off-center load compensation ("SIMPLE" – "AVERAGE" – "PRECISE"). They are described in the following sections.



TIP

In the adjustment variants "AVERAGE" and "PRECISE", the segment point (segment corner) to be loaded is shown in the adjustment dialog. If the load is not applied to the displayed point, the measured value display of the loaded point (corner) flashes. Place the weight on the displayed point to continue with the adjustment.

10.7.1 Off-center load compensation mode “SIMPLE”

The scale is loaded in the center. The measured values of all participating load cells are acquired for the unloaded scale and the scale loaded with the balancing weight. The off-center load error is compensated using the measured values of the participating load cells.

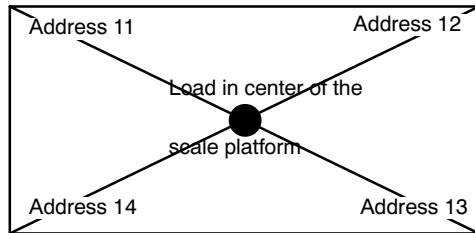

Fig. 10.6: Segment 1 with four load cells

Display representation “SIMPLE” adjustment with 4 load cells ADR11 ... ADR14:

LC CALIBRATION (SIMPLE) : SEGMENT 1	
Measured value	Measured value
ADR 11	ADR12
Characteristic curve is reset!	
Measured value	Measured value
ADR 14	ADR13
START	
F1	F2
F3	F4

The four load cells with the addresses 11 ... 14 display the measured values of the corresponding load cell above the address.

A previous adjustment is deleted with the key “F1” (START), the dialog then continues with the UNLOADED SCALE window. The scale should now be unloaded. The four load cells with the addresses 11 ... 14 display the measured values of the corresponding load cell above the address.

Display representation “SIMPLE” adjustment with 4 load cells ADR11 ... ADR14, zero value:

LC CALIBRATION (SIMPLE) : SEGMENT 1	
Measured value	Measured value
ADR 11	ADR12
UNLOADED SCALE	
Measured value	Measured value
ADR 14	ADR13
ZERO	
F1	F2
F3	F4

The four load cells with the addresses 11 ... 14 display the measured values of the corresponding load cell above the address.

The dialog can be left with the key "CE" without deleting the previous adjustment.

The measured values are accepted when the display is still with the "F1" key (ZERO), the dialog then continues with the next window.

Display representation "SIMPLE" adjustment with 4 load cells ADR11 ... ADR14, load value:

LC CALIBRATION (SIMPLE) : SEGMENT 1			
Measured value			Measured value
ADR 11			ADR12
	5.000		
Measured value			Measured value
ADR 14			ADR13
LOAD			
F1	F2	F3	F4

The selected balancing weight is displayed in the center. The scale must be loaded in the center with the balancing weight. The load cells display the measured value of the load cell above the address for the scale loaded with the balancing weight. The measured values are accepted when the display is still with the "F1" key.

As soon as all corners are loaded, the set scale characteristic curve is calculated. The message "Completed successfully!" appears in the display. Confirm this selection with the "F4" key.

The off-center load compensation in "SIMPLE" mode is then complete.

10.7.2 Off-center load compensation mode “AVERAGE”

The scale is loaded each time in the center with the calibration weight between two neighboring load cells. 3 measured values are acquired for a platform scale with 4 load cells:

1. Unloaded scale
2. Calibration weight between load cell 11 and 14
3. Calibration weight between load cell 12 and 13

The load location is displayed in the adjustment menu.

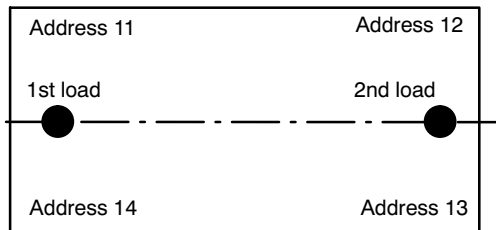

Fig. 10.7: Segment 1 with four load cells

Display representation “AVERAGE” adjustment with 4 load cells ADR11 ... ADR14:

LC CALIBRATION (AVERAGE) : SEGMENT 1	
Measured value	Measured value
ADR 11	ADR12
Characteristic curve is reset!	
Measured value	Measured value
ADR 14	ADR13
START	
F1	F2
	F3
	F4

The four load cells with the addresses 11 ... 14 display the measured values of the corresponding load cell above the address.

A previous adjustment is deleted with the key “F1” (START), the dialog then continues with the UNLOADED SCALE window. The scale should now be unloaded. The four load cells with the addresses 11 ... 14 display the measured values of the corresponding load cell above the address.

Display representation “AVERAGE” adjustment with 4 load cells ADR11 ... ADR14, zero value:

LC CALIBRATION (AVERAGE) :		SEGMENT 1	
Measured value		Measured value	
ADR 11		ADR12	
UNLOADED SCALE			
Measured value		Measured value	
ADR 14		ADR13	
ZERO			
F1	F2	F3	F4

The four load cells with the addresses 11 ... 14 display the measured values of the corresponding load cell above the address.

The dialog can be left with the key “CE” without deleting the previous adjustment.

The measured values are accepted when the display is still with the “F1” key (ZERO), the dialog then continues with the next window.

Display representation “AVERAGE” adjustment with 4 load cells ADR11 ... ADR14, load value:

LC CALIBRATION (AVERAGE) :		SEGMENT 1	
Measured value		Measured value	
ADR 11		ADR12	
5.000			
Measured value		Measured value	
ADR 14		ADR 13	
LOAD 1			
F1	F2	F3	F4

The balancing weight with the black background indicates where the scale must be loaded with the balancing weight (in the center between ADR11 and ADR14). The load cells display the measured value of the load cell above the address for the scale loaded with the balancing weight. The measured values are accepted when the display is still with the “F1” key.

As soon as both sides are loaded, the set scale characteristic curve is calculated. The message “Completed successfully!” appears in the display. Confirm this selection with the “F4” key.

The off-center load compensation in “AVERAGE” mode is then complete.

10.7.3 Off-center load compensation mode “PRECISE”

In the adjustment mode “PRECISE”, *each* load cell is loaded with the calibration weight. Five measured values are therefore acquired for a platform scale with 4 load cells.

1. Unloaded scale
2. Calibration weight on load cell 11
3. Calibration weight on load cell 12
4. Calibration weight on load cell 13
5. Calibration weight on load cell 14

The load location is displayed in the adjustment menu.

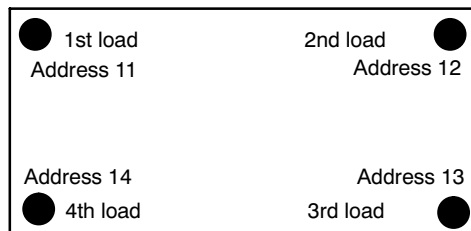

Fig. 10.8: Segment 1 with four load cells

Display representation “PRECISE” adjustment with 4 load cells ADR11 ... ADR14:

LC CALIBRATION (PRECISE) : SEGMENT 1	
Measured value	Measured value
ADR 11	ADR12
Characteristic curve is reset!	
Measured value	Measured value
ADR 14	ADR13
START	
F1	F2
	F3
	F4

The four load cells with the addresses 11 ... 14 display the measured values of the corresponding load cell above the address.

A previous adjustment is deleted with the key “F1” (START), the dialog then continues with the UNLOADED SCALE window. The scale should now be unloaded. The four load cells with the addresses 11 ... 14 display the measured values of the corresponding load cell above the address.

Display representation “PRECISE” adjustment with 4 load cells ADR11 ... ADR14, zero value:

LC CALIBRATION (PRECISE) : SEGMENT 1			
Measured value		Measured value	
ADR 11		ADR12	
UNLOADED SCALE			
Measured value		Measured value	
ADR 14		ADR13	
ZERO			
F1	F2	F3	F4

The four load cells with the addresses 11 ... 14 display the measured values of the corresponding load cell above the address.

The dialog can be left with the key “CE” without deleting the previous adjustment.

The measured values are accepted when the display is still with the “F1” key (ZERO), the dialog then continues with the next window.

Display representation “PRECISE” adjustment with 4 load cells ADR11 ... ADR14, load value:

LC CALIBRATION (PRECISE) : SEGMENT 1			
Measured value		Measured value	
ADR 11		ADR12	
↑5.000			
Measured value		Measured value	
ADR 14		ADR13	
LOAD 1			
F1	F2	F3	F4

The balancing weight with the black background indicates, with an arrow, where the scale must be loaded with the balancing weight (in Fig. ADR 11). The load cells display the measured value of the load cell above the address for the scale loaded with the balancing weight. The measured values are accepted when the display is still with the “F1” key.

As soon as all corners are loaded, the set scale characteristic curve is calculated. The message “Completed successfully!” appears in the display. Confirm this selection with the “F4” key.

The off-center load compensation in “PRECISE” mode is then complete.

10.7.4 Off-center load compensation mode “INPUT”

Preparation:

1. Call the parameter menu “OFF-CENTER LOAD COMPENSATION”.
2. Call the menu “INPUT SEGMENT 1(2,3)”.
The segments 2 and 3 are only displayed when “2 segments” or “3 segments” is set in the menu “SCALE CONFIGURATION → SEGMENT NUMBER”.
The load cells belonging to the selected segment are displayed with their addresses, e.g. segment 1 with 4 load cells: Display correction value 11... 14.

Procedure for entering the correction values:

1. Display measured value display (exit parameter menu).
2. Load the 4 corners consecutively with a known weight. Note the weight values.
3. Note the deviation between displayed weight and known weight.
4. Calculate, for each corner, the compensating value based on the scale maximum capacity using the formula “Maximum capacity/known weight * measured deviation”.
5. Enter the calculated values for the individual load cells in the parameter menu “OFF-CENTER LOAD COMPENSATION → INPUT SEGMENT 1”.
6. Check the deviations in the measured value display and adjust where necessary.

Example:

The scale consists of one segment (segment 1). The scale maximum capacity is 100 kg (display = 100.00 kg), the known balancing weight is 25 kg. At corner 11, the weight is displayed with 24.90 kg.

1. Calculate the deviation:
 $24.90 \text{ kg} - 25.00 \text{ kg} = -0.10 \text{ kg}$ (displayed weight – balancing weight)
2. Convert deviation using nominal value:
 $100.00/25.00 * (-0.10) = -0.40$
3. Enter correction in parameter menu “OFF-CENTER LOAD COMPENSATION → CORRECTION VALUE 11”:
-0.40 kg
4. Proceed in the same manner with the correction values for load cells 12, 13 and 14.
5. After input, check the corners again and repeat the inputs if necessary.

10.8 Multi-range weighing machine

The DIS2116 can be operated as a single-range or multi-range scale.

Two parameters are available for this in the “SCALE PARAMETERS → PARAMETER” parameter menu: “MULTIRANGE 1” AND “MULTIRANGE 2”. The weighing range (“NOMINAL VALUE”) must be set before this setting.

Scale type	Parameter
Single-range balance	MULTIRANGE 1 = MULTIRANGE 2 = 0
Dual-range balance	0 < MULTIRANGE 1 < NOMINAL VALUE and MULTIRANGE 2 = 0
Three-range scale	0 < MULTIRANGE 1 < MULTIRANGE 2 < NOMINAL VALUE

The increment for the second and third weighing range is automatically derived from the “RESOLUTION” parameter, whereby this parameter always describes the increment of the first measuring range.

Example:

“RESOLUTION” = 1d → Increment range 2 = 2d → Increment range 3 = 5d

10.9 Taking gravitational acceleration into account

The gravitational acceleration, and thus the scale display, is dependent on the geographical data of the place of installation. The maximum variation between the different regions within the Federal Republic of Germany is 0.1%; worldwide, it is 0.6%.

The function described below allows adjustment to take place on the scale manufacturer’s premises, even if the device is to be operated at a different geographical location.

If the fault effect at the new installation location exceeds the scale accuracy limits, it is usually necessary to re-adjust. It is also possible to use the internal correction function in the DIS2116 to compensate for the effect of the installation location. To do this, input the following in the “SCALE PARAMETERS → PARAMETER menu (access authorization required!):

- “G-FACTOR CALIBRATION.” = Gravitational acceleration factor for the calibration location.
- “G-FACTOR APPLICATION” = Gravitational acceleration factor for the destination location (where the scale is used).

This must be entered after scale adjustment.

Use the setting “G-FACTOR CALIBRATION” = G-FACTOR APPLICATION to disable the correction calculation. The display is then always related to the location of the last calibration.



TIP

This setting is not required if the scale is adjusted on site.

11 Linearization

For most scale applications, standard adjustment with the zero and full scale values (“ENTRY” or “MEASUREMENT”) is sufficient. The signal only needs to be linearized (“LINEARIZATION”) if unacceptable errors occur with this method. Linearization corrects errors when scale structures have an output signal that is not proportional to the weight (e.g. because there are mechanical transmission elements).

Correction selection via the menu “SCALE PARAMETERS → LINEARIZATION:

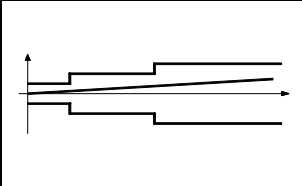
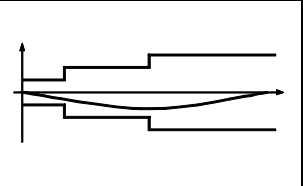
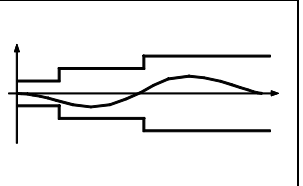
Calibration steps	Zero value, full scale value ¹⁾	Two additional calibration weights	Two additional calibration weights
Recommended for:	Standard application	Structures with a linearity error	Structures with a linearity error
Possible to correct the following errors:	Error proportional to the measured value	One maximum of the error char. curve	Two maximums of the error char. curve
Example: (Scale output signal error, as per OIML)			

¹⁾ Zero and full scale value adjustment is already described in Chapter 10.

For the linearization method, proceed as follows:

1. Set the scale parameters.
2. Calibrate the scale at two points (zero and calibration weight) or via off-center load calibration (Chapter 10, Page 65).
3. Measure the linearity error in the weighing range with two additional calibration weights.



IMPORTANT







Correction is only possible when measurements can be performed. Input only makes sense when the linearity adjustment has been implemented, the determined values are reset for test purposes and now need to be input again.

Linearization always takes place at two measurement points (actual values). First establish whether the error characteristic curve has one or two maximums (see above).

If the error characteristic curve has one maximum, the first measurement point is put at about $500d = e$ (the narrowest part of the error characteristic curve). The second measurement point is put at the maximum of the error characteristic curve.

If the error characteristic curve has two maximums, the first measurement point is put at the first maximum and the second point at the second maximum.

The table below shows an extract from the parameter menu:

SCALE PARAMETERS → LINEARIZATION		Access level 4	
	WEIGHT 1		Setpoint input for measurement point 1
	MEASURED VALUE 1		The measured value of the scale loaded with weight 1 is displayed and accepted with "ENTER".
	MEASURED VALUE 1 ENTRY		If the measured value for weight 1 is noted, it can be entered again here.
	WEIGHT 2		Setpoint input for measurement point 2
	MEASURED VALUE 2		The measured value of the scale loaded with weight 2 is displayed and accepted with "ENTER".
	MEASURED VALUE 2 ENTRY		If the measured value for weight 2 is noted, it can be entered again here.

Adjustment procedure:

- The scale is already adjusted in its weighing range.
- Any linearization present is disabled (weight 1 = weight 2 = measured value 1 = measured value 2 = 0).
- Call the "WEIGHT 1" sub-menu.
- Enter the value for calibration weight 1.
- Load the scale with the calibration weight 1.
- Call up the sub-menu "MEASURED VALUE 1", the measured value is displayed with internal resolution.
- Wait until the measured value display is steady.
- Press the "ENTER" key to store the value. The first value pair is now acquired.
- Call the "WEIGHT 2" sub-menu.
- Enter the value for calibration weight 2.
- Load the scale with the calibration weight 2.
- Call up the sub-menu "MEASURED VALUE 2", the measured value is displayed with internal resolution.
- Wait until the measured value display is steady.
- Press the "ENTER" key to store the value.

After input and measurement of both interpolation points, the linearization coefficient is calculated and the characteristic curve linearized.

12 Legal-for-trade applications

Once the scale parameters are set and the scale adjusted in the “SCALE PARAMETERS” menu, the DIS2116 must be set to legal-for-trade applications (OIML or NTEP) using the parameter menu “MODE → LFT CAPABILITY”. This protects the legal-for-trade parameters in the DIS2116 and load cells against further change and the legal-for-trade counter, which cannot be reset, increases by one. The maximum number for the legal-for-trade counter is 9999999. It cannot go over this and cannot be reset.

Legal-for-trade counter (TCR) display

There are two options for displaying the trade counter (TCR):

1. Permanent TCR in INFO line 1 or 2: Select parameter menu “DISPLAY → DISPLAY LINE 1” or “DISPLAY → DISPLAY LINE 2”.
2. In scale label: Key “F1” when “I” is displayed in the function line, switch function line with “F4”).



IMPORTANT *The DIS2116 does not check whether the parameter settings made are valid under OIML R76 or NTEP.*

Before leaving the “MODE” menu, the “ACCESS LEVEL” parameter in the parameter menu “MODE” must be appropriately set.

“ACCESS LEVEL” parameter

The various menu levels have what are called access authorizations. Parameter “MODE → ACCESS LEVEL” is used to define the access for changing parameters. The level with the most restrictions for user access is zero.

The “MODE → ACCESS LEVEL” parameter is protected by the hidden pushbutton. The applicable access level for each parameter is specified in the parameter description.

ACCESS LEVEL parameter	Enabled access levels
0	0 only
1	0 and 1
2	0 to 2
3	0 to 3
4	0 to 4
5	All, factory settings

Legal-for-trade parameters in the main menu:

Access level	Main menu level	Explanation	Legal-for-trade parameter ¹⁾
0	INFORMATION	Information	-
1	PRINT	Printing	-
2	LIMIT VALUE	Limit values	-
4	FILTER	Filter	-
4	COMMUNICATION	Interface settings	-
3	PRINT PROTOCOL	Print protocol settings	-
4	CLOCK	Real-time setting	-
4	FUNCTION KEYS	Function key assignments	Yes
4	DISPLAY	Setting the Info line 1 and 2 contents, contrast	-
0	FUNCTION TEST	DIS2116 test functions	-
0	MODE	Basic scale functions	Yes
5	SCALE CONFIGURATION	Segments, load cells	Yes
5	SCALE PARAMETERS	Basic scale functions	Yes
5	OFF-CENTER LOAD COMPENSATION	Off-center load error compensation	Yes
5	FACTORY SETTINGS	Restore the factory settings	Yes

¹⁾ Access only via hidden pushbutton

When you exit the parameter menu "MODE", all the legal-for-trade parameters are protected (display only, changes cannot be made).

The legal-for-trade counter can be read in the menu "INFORMATION → SCALE" (Section 8.4.1, Page 38).

Fill out the supplied insertion strip in accordance with the set application and insert in the front foil. Attach the calibration and sealing label to then secure the hidden switch and the insertion strip.

The calibration label is applied according to the applicable national legislation.

The parameter menu can now only be called up via the  key.

If the scale has to be re-adjusted or new parameters have to be set that are relevant to verification, proceed as follows:

- Remove the calibration label and the insertion strip.
- Call the parameter menu via the hidden pushbutton.
- Change the “MODE → LFT CAPABILITY” parameter to “NO”.
- Set parameter “MODE → ACCESS LEVEL” to 5.

Setting the parameter to legal-for-trade applications produces the following display and tare ranges:

MODE → LFT CAPABILITY	Display, lower limit value	Display, upper limit value
NO (not legal-for-trade)	-160%	160%
OIML	-20 d	Nominal value +9d
NTEP	-2%	105%

MODE → LFT CAPABILITY	Tare range, lower limit	Tare range, upper limit
NO (not legal-for-trade)	-100%	100%
OIML, NTEP	>0	100%

MODE → LFT CAPABILITY	Range of zero setting, lower limit	Range of zero setting, upper limit
NO (not legal-for-trade)	-20%	+20%
OIML, NTEP	-2%	+2%

The % figures relate to the nominal weighing range (menu “SCALE PARAMETERS → PARAMETER → NOMINAL VALUE”).

The weighing electronics must be labeled and sealed in accordance with the scale application. Different labeling strips are included for use as a Class III and IIII non-automatic scale. The labeling strip must contain at least the following data:

Max	Maximum scale loading
Min	Minimum scale loading
e	Increment
Type	Name of scale
S.N.	Individual serial number of scale

In the case of legal-for-trade scales, verification must be performed by a Notified Body, in accordance with current national laws. The sealing and calibration labels must be attached in accordance with the approval.

13 Vehicle scale

In the “Vehicle scale” operating mode, all functions required for weighing vehicles are activated:

- Additional vehicle weighing functions on keys “F1” to “F4”.
- Database for storage of vehicle data, material, procedure. Data for max. 65000 vehicles can be stored.
- “Yard list” for arriving vehicles recorded with Weighing1 but which have not yet departed (Weighing2). The “Yard list” holds max. 50 vehicles.
- Functions for creating and editing vehicle data.
- Storage of weighing results with Weighing1 (2), tare, vehicle data, date and time.

13.1 Activate “Vehicle scale” operating mode

Access: Key , **MODE**  **OPERATING**  (Enter)

Sub-menu explanation			
	OPERATING MODE		Standard*
			Vehicle
			Activate “Vehicle” operating mode

 **IMPORTANT** *If the DIS2116 has been set to legal-for-trade applications (OIML, NTEP), the operating mode cannot be changed.*

When the DIS2116 is set to vehicle scale with “MODE- → OPERATING MODE- → VEHICLE”, the function keys “F1” to “F4” are assigned additional functions for vehicle weighing. The assignments of keys are displayed in the measured value display function line by pressing “F4” several times.

In the vehicle scale setting, there are three switchable function lines which can be selected with the F4 key.

Function line for vehicle weighing:

F1	F2	F3	F4
	→]	[→	↓ Level 1
Database	Vehicle list	Yard list	Scroll to Level 2

13.2 Edit database

Press the “F4” key until the next function line appears

				Function line
F1	F2	F3	F4	Keys
Database	Vehicle list Arrival	Yard list Departure	Scroll to Level 2	

The database is selected by pressing “F1”.



Each time “F1” is pressed, the mode switches between *Edit database* and *Vehicle selection*.

Display of vehicle list

Truck list - total			
Search:			
Truck	Goods	Procedure	Date
F-RA 123	Gravel	Pickup	10.09.08
.....	
F1	F2	F3	F4

The Truck, Goods and Procedure columns can be assigned entries with maximum 10 characters. The Date cannot be entered, the last date on which the vehicle data was edited is displayed.

Vehicle search

There are two ways to search for a vehicle in the Truck list:

1. Search with keys (“F2”) and (“F3”)

Key “F2” is used to search the entries in the Truck column alphabetically from A to Z and key “F3” from Z to A. The applicable vehicle is indicated by a black bar.

2. Search using text

Use the keyboard to enter the number plate of the vehicle being sought. The search starts with the first character entered. The first number plate that starts with this character is then displayed in the first line under “Truck” and is marked by a black bar. The search is refined with every additional character that is entered.

If there is no vehicle that starts with the entered letter, the next vehicle is shown that starts alphabetically with the letter after that entered.

The search text can be deleted with the “F4” key (). The vehicle display changes to match the remaining search text. If the search text is completely deleted, the first vehicle in the alphabetically sorted list is displayed.

directly opens the editor window of the selected vehicle, see “Editing vehicle data”.

13.2.1 Editing vehicle data

The “F1” (↵) key switches the function line mode between *Find vehicle* and *Edit vehicle*.

Display representation of the function line ”Edit vehicle data”

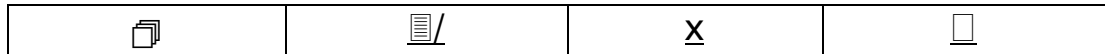

Press the “F2” key to open the editor window for the selected vehicle (marked with a black bar).

Display representation of the Editor window

Truck list - 			
Truck	:F-RA 123	■	
Goods	:Gravel		
Procedure	:Pickup		
Emptyw.	:10.000 t		
Max. weight	:15.000 t		
Min. weight	:10.100 t		
↓	←	→	←X

Key “F1” moves the cursor into the required line.

Key “F2” moves the cursor left, ”F3” right.

Key “F4” deletes the line character by character from the right.

The unit cannot be deleted, this corresponds to the unit set in the parameter menu “SCALE PARAMETERS → PARAMETER”.

13.2.2 x Delete vehicle

The “F1” (↵) key switches the function line mode between *Find vehicle* and *Edit vehicle*.

Display representation of function line “Edit vehicle data”

F1	F2	F3	F4

Press the “F3” (X) key to delete the selected vehicle (marked by a black bar) from the database.

13.2.3 □ Create vehicle

The “F1” (↵) key switches the function line mode between *Find vehicle* and *Edit vehicle*.

Display representation of function line “Edit vehicle data”

F1	F2	F3	F4

Press the “F4” (□) key to open an empty editor window. The entries can be made here as described in Section 13.2.1, “Edit vehicle data”.

The entered data is stored with the key. An empty window cannot be saved.

Use the key to close the window without saving the data.

13.3 Vehicle weighing mode “ARRIVAL/DEPARTURE”

In the vehicle weighing mode “ARRIVAL/DEPARTURE”, the weight determination for the load is based on 2 measurements. The weight of the arriving truck is recorded with Weighing1 and the weight of the departing truck with Weighing2. The difference is the weight of the loaded or unloaded material.

It is also possible to use the empty weight (pretare) stored with the truck data as the weight for the arriving truck. The arriving truck then does not need to drive onto the scale.

Press the “F4” key until this function line appears:

				Function line
F1	F2	F3	F4	Keys
Database	Vehicle list Arrival	Yard list Departure	Scroll to Level 2	

Arriving vehicle

Key “F2” opens the vehicle list which contains all stored vehicles.

Use the arrow keys (“F2”, “F3”) or the search text to select the applicable vehicle or create a new one with “F1” (Section 13.2.1 or 13.2.3).

The key confirms the selection. The measured value window with the actual measured value is displayed. The weight of the arriving vehicle is recorded in the window “Weigh1”.

Weigh1

Record measured value?

10.535 t

Pretare			
F1	F2	F3	F4

If the manual tare function is activated (“SCALE PARAMETERS → PARAMETER → MANUAL TARE MODE” = “ON”), the key “F1” can be used to accept the entered empty weight (Pretare), without the truck standing on the scale. The displayed weight is accepted with “F4”.

After arrival of the vehicle, it is entered into the list of the accepted vehicles, the so-called “Yard list”. This completes the arrival procedure.

Departing vehicle

Press the “F4” key until this function line appears:

				Function line
F1	F2	F3	F4	Keys
Database	Vehicle list Arrival	Yard list Departure	Scroll to Level 2	

The key “F3” opens the vehicle list (Yard list) which contains all arrived vehicles.

Use the arrow keys (“F2”, “F3”) or the search text to select the applicable vehicle.

The key confirms the selection. The measured value window with the actual measured value is displayed. The weight of the departing vehicle is recorded in the window Weigh2.

Weigh2

Record measured value?

11.535 t

The displayed weight is accepted with the key “F4”. After the weight of the departing vehicle is recorded with Weigh2, the vehicle must be deleted from the Yard list.

The weighing result and the weight during arrival and departure are stored together with the vehicle number plate, date and time, plus a sequential print number, on the SD card.

This completes the weighing process for a vehicle.

The weighing result can be seen in the parameter menu “INFORMATION →WEIGHING RESULT” (Section 8.4.1, Page 38), on a second display (COM4) and printed out on a printer (Chapter 14, Page 92).

14 Print function



A printer can be connected to the serial interface COM3 (RS-232) or the USB printer interface of the DIS2116 to print out the weight values.

14.1 Activating the printer interface

Access: Key , **COMMUNICATION**  **PRINTER**  (Enter)

		Sub-menu explanation	
	FUNCTION		Selecting the printer interface
			OFF COM3 and USB disabled
			ON (COM3)* Serial printer connection active (RS-232)
			ON (USB) USB printer connection active

If the USB printer interface is used, no further settings are necessary. The following menu is only displayed when COM3 is selected as the serial printer connection.

		Sub-menu explanation	
	BAUD RATE		The following baud rates can be set: 1.2k, 2.4k, 4.8k, 9.6k*, 19.2k, 38.4k, 57.6k and 115.2k baud
	PARITY		The following settings can be selected for parity: None* – Even – Odd
	PROTOCOL		The DIS2116 has two communications protocols to the printer: DTR : Hardware protocol, driven by the DTR signal DC1* : Software protocol, driven by DC1/DC3

* Factory settings

14.2 DIS2116 – printer connection





The DIS2116 is equipped with a serial printer output COM3 and a USB printer connection. Interface selection is described in Section 8.4.5, Page 43.

Printer connection

- COM3: Standard printer cable 9-pin SUB-D. The assignment of the COM3 interface is described in Section 5.10, Page 23.
- USB: Standard USB cable.

14.3 Print protocol selection

The print function is only accessible if COM3 or USB is activated for printing.

			Sub-menu explanation	
PRINT			Access level 4	
	MEASURED VALUE		Selection of print protocol PRT01 to PRT05	
	WEIGHING 1 ¹⁾		Automatic printout after Weighing 1	
	WEIGHING 2 ¹⁾		Automatic printout after Weighing 2	
	PARAMETERS		SCALE PARAMETERS	Printout of load cell parameters
			DIS2116 PARAMETERS	Printout of DIS2116 parameters
			BUS SCAN RESULT	Printout of load cells connected to the DIS2116

¹⁾ Only in "VEHICLE" operating mode

14.4 Print protocols

The following print protocols are available:

- PRT01-MV: Gross or net and tare
- PRT02-MV1: Gross or net Weighing 1 and tare for vehicle scale
- PRT03-MV2: Gross or net Weighing 2 and tare for vehicle scale
- PRT04-Total: Gross or net Weighing 1, Weighing 2 and result (Weighing 2 – Weighing 1)
- PRT05-Result: Gross or net result (Weighing 2 – Weighing 1)

1. Protocol PRT01 Gross:

User-defined line 1			
User-defined line 2			
User-defined line 3			
Date	:	27.02.2012	
Time	:	10.24	
Scale ID	:	DIS2116	
Printout No.	:	57	
Weighing	G :	498.8	kg

The first three lines (Identstring 1 ... 3) can be input via the parameter menu "PRINT PROTOCOL → USER DEFINED LINE 1 (2, 3)":

- Via the membrane keypad
- Via an external keyboard which can be connected via the PS/2 input
- Via the computer interface COM2 (see Manual Part 2, Commands **PS1**, **PS2**, **PS3**).

Any content, to a maximum of 30 characters in each case, can be stored here. These three lines are inactive at the factory and they are not printed out.

The scale ID line is the production number of the scale (specified by the manufacturer).

The printout No. is a sequential number which is increased with each printout.

In the Weighing line, only the gross value (G) is printed out.

2. Protocol PRT01 Net:

User-defined line 1			
User-defined line 2			
User-defined line 3			
Date	:	27.02.2012	
Time	:	10.27	
Scale ID	:	DIS2116	
Printout No.	:	59	
Weighing	N :	425.3	kg
Tare	:	1.2	kg

In the case of the weighing line, the line with the net value (N) is printed out. In the tare line, only the tare value is printed out.

3. Protocol PRT01 Net with manual tare:

User-defined line 1			
User-defined line 2			
User-defined line 3			
Date	:	27.02.2012	
Time	:	10.31	
Scale ID	:	DIS2116	
Printout No.	:	62	
Weighing	N :	532.7	kg
Tare PT	:	27.2	kg

In the case of the weighing line, the line with the net value (N) is printed out. In the tare PT line, only the manual tare value is printed out.

4. Protocol PRT02 Gross:

User-defined line 1			
User-defined line 2			
User-defined line 3			
Date	:	28.02.2012	
Time	:	11.05	
Scale ID	:	DIS2116	
Truck ID	:	DA-HM 100	
Goods ID	:	TPA4753	
Procedure ID	:	DSS	
Weighing	G :	498.8	kg

The vehicle data, a goods ID and a procedure ID are also printed out in this protocol.

5. Protocol PRT02 Net with manual tare:

User-defined line 1			
User-defined line 2			
User-defined line 3			
Date	:	28.02.2012	
Time	:	11.12	
Scale ID	:	DIS2116	
Truck ID	:	DA-HM 100	
Goods ID	:	TPA4753	
Procedure ID	:	DSS	
Weighing	N :	-----	kg
Tare PT	:	10000	kg

In the case of the weighing line, the line with the net value (N) is printed out. In the tare PT line, only the manual tare value is printed out.

6. Protocol PRT03:

User-defined line 1			
User-defined line 2			
User-defined line 3			
Date	:	19.03.2012	
Time	:	10.03	
Scale ID	:	DIS2116	
Printout No.	:	112	
Truck ID	:	DA-HM 100	
Goods ID	:	TPA4753	
Procedure ID	:	DSS	
Weighing 2	G	: 6089	kg

7. Protocol PRT04:

User-defined line 1			
User-defined line 2			
User-defined line 3			
Date	:	19.03.2012	
Time	:	10.14	
Scale ID	:	DIS2116	
Printout No.	:	114	
Truck ID	:	DA-HM 100	
Goods ID	:	TPA4753	
Procedure ID	:	DSS	
Weighing 1	G	: 4075	kg
Weighing 2	G	: 6089	kg
Result	G	: 2014	kg

The vehicle data, a goods ID and a procedure ID, the empty vehicle weight (Weight1), the loaded vehicle weight (Weight2) and the result are also printed out in this protocol in addition to the vehicle data.

8. Protocol PRT05:

User-defined line 1				
User-defined line 2				
User-defined line 3				
Date		:	19.03.2012	
Time		:	10.14	
Scale ID		:	DIS2116	
Printout No.		:	114	
Truck ID		:	DA-HM 100	
Goods ID		:	TPA4753	
Procedure ID		:	DSS	
Result		G	:	2014
				kg

In contrast to PRT04, only the result is printed out in this protocol, not the individual weighings.

14.5 Starting the printing process

Start the printing process in the measured value display with key “F1”, when the symbol for printing () is displayed above “F1”.



The symbol  is only displayed when the function is set to “ACTIVE” in the parameter menu “FUNCTION KEYS → PRINT”. If the symbol is still not displayed, change the assignment of the function keys by pressing the key “F4” until the print symbol is displayed.

What is printed out depends on the operating state of the scale and always corresponds to what is shown on the display. Printing only takes place when there is standstill, so the unit of measurement is always printed out.

With non legal-for-trade applications, printing can take place as often as required.

With a legal-for-trade setting, the printout cannot be repeated. There must be a change in weight and a renewed standstill before there can be a new printout. There is no printing outside the display limits.

Every measured value printout with print protocol PRT01 is stored in the ALIBI memory on the SD card.

14.6 Automatic printing

Automatic printout is possible after a weighing. The output is only implemented when weighing is successful.

To do this enter the print protocols to be used in the parameter menu “PRINT → WEIGHING 1” or “PRINT → WEIGHING 2”:









- Only PRT01 can be selected for the print protocol after Weighing 1.
- Protocols PRT03, PRT04 and PRT05 are available for the print protocol after Weighing 2.

15 Interface for a second display





An external, second display can be connected to the serial interface COM4 (RS-232). The connection of COM4 (9 pin SUB-D) is described in Section 5.8 (Page 22).

15.1 Activating COM4 for a second display

Access: Key , **COMMUNICATION**  **EXT. DISPLAY**  (Enter)

COMMUNICATION → EXT. DISPLAY (COM4)		Access level 4
FUNCTION		OFF* – COM4 disabled Selection of display string, String 1 to String 5
STANDARD DISPLAY ¹⁾		– None microSYST MIGRA (numerical display) microSYST MIGAN (graphical display)
PROTOCOL		The DIS2116 has two transmission protocols for external display: OFF* = No handshake DTR = Hardware protocol controlled via the DTR signal DC1 = Software protocol controlled with DC1/DC3
BAUD RATE		The following baud rates can be set: 1.2k, 2.4k, 4.8k, 9.6k*, 19.2k, 38.4k, 57.6k and 115.2k baud
PARITY		The following settings can be selected for parity: NONE EVEN ODD
START STRING LENGTH		0* = No start string 1 ... 15 = Number of characters for the start string
Character 1 ... Character 15 ²⁾		Entry of any ASCII characters as decimal values
END STRING LENGTH		0* = No end string 1 ... 5 = Number of characters for the end string

Parameter menu COMMUNICATION → EXT. DISPLAY (continued)

Character 1 ... Character 5 ³⁾		Entry of any ASCII characters as decimal values
CRC		OFF* = No checksum ON = Checksum
DECIMAL POINT		POINT* = The decimal point is displayed as a point COMMA = The decimal point is displayed as a comma OFF = No decimal point
PAUSE [10ms]		Time between two display changes, can be set in 10 ms steps up to max. 2.5 s
MEASURED VALUE LENGTH		Number of measured value digits that can be displayed Standard (9 digits) 2 ... 9 digits for the measured value

* Factory settings

- 1) When connecting and selecting a standard display, the interface COM4 is automatically configured, no further settings are required under EXT. DISPLAY (COM4). For specifications for the standard displays, please refer to the manufacturer's documentation.
- 2) A start string consisting of max. 15 characters can be sent before strings 1 ... 5. The characters are input as decimals (e.g. an empty space with the value 32 (20hex)). The values can be found in an ASCII table. The number of characters entered must not exceed the number set in "START STRING LENGTH". The input menu item is not displayed if the "START STRING LENGTH" = 0.
- 3) An end string consisting of max. 5 characters can be sent after strings 1 ... 5. The characters are input as decimals (e.g. an empty space with the value 32 (20hex)). The values can be found in an ASCII table. The number of characters entered must not exceed the number set in "END STRING LENGTH". The input menu item is not displayed if the "END STRING LENGTH" = 0.

There are 5 selectable telegrams (String 1 to String 5), which can be displayed on an external display. The telegrams have the following contents:

- String 1 Gross or net value + unit, max. 19 characters
- String 2 Gross or net value + unit and tare value, max. 28 characters
- String 3 Weighing result + unit, max. 19 characters
- String 4 Gross or net value, max. 9 characters
- String 5 Gross or net value + unit + status, max. 17 characters

The checksum CRC is a XOR combination of all transmitted characters (first start string character to last end string character).

Detailed description

Char.	1	2	3	4	5	6	7	8	9	10	11	12	13	14
String1	ER	M1	M1	M1	M1	M1	M1	M1	M1	ES	U	U	U	U
String2	ER	M1	M1	M1	M1	M1	M1	M1	M1	ES	U	U	U	U
String3	ER	W1	W1	W1	W1	W1	W1	W1	W1	ES	U	U	U	U
String4	ER	M1	M1	M1	M1	M1	M1	M1	M1	-	-	-	-	-
String5	ER	M1	M1	M1	M1	M1	M1	M1	M1-	S1	S2	S3	ES	U

Char.	15	16	17	18	19	20	21	22	23	24	25	26	27	28
String1	ES	GN	GN	GN	GN	-	-	-	-	-	-	-	-	-
String2	ES	GN	GN	GN	GN	ER	T1	T1	T1	T1	T1	T1	T1	T1
String3	ES	GN	GN	GN	GN	-	-	-	-	-	-	-	-	-
String4	-	-	-	-	-	-	-	-	-	-	-	-	-	-
String5	U	U	U	-	-	-	-	-	-	-	-	-	-	-

If no decimal indicator is set (CMD KC4=0), the characters are offset.

SN	Sign “-” or empty space
M1	Measured value* (7/8 characters)
W1	Weighing result* (7/8 characters)
T1	Tare value* (7/8 characters)
ES	Empty space
U	Unit (4 characters)
GN	Gross/Net display (“G”, “NET”, “N PT”) at standstill, otherwise empty space (4 characters)
S1	Gross/Net display (“G”, “N”) (1 character)
S2	Standstill display (“M”) or empty space (1 character)
S3	Weighing range (“1”, “2”, “3”) or empty space (1 character)



The length of the values M1, W1 and T1 depend on whether a decimal indicator has been set or not.

16 Limit values

The DIS2116 has two programmable limit values. Each channel becomes active when the activation value is overrun and inactive when the deactivation value is underrun. The different values give a free choice of hysteresis. The values can be related to the gross or the net weight, as desired; this is not dependent on the current display mode.

The parameters for the limit value switches are described in Section 8.4.3 (Page 41).

Active limit value channels are displayed by the symbols  1,2 in the status line of the display.

 1 Limit value 1 active, limit value 2 not active or off

 12 Limit values 1 and 2 active

 2 Limit value 1 not active or off, limit value 2 active

 No limit value active

17 Alibi and calibration memory

The DIS2116 is equipped with an SD card to store the legal-for-trade parameters. The main print protocol information is stored on the SD card during every printout. The data is stored encrypted on the SD card.

Storage is implemented irrespective of whether it is a legal-for-trade application or if a printer is connected.

The following data are stored during printing (“F1” when the symbol  is displayed):

- Print number
- Date and time
- Gross/Net/Tare selection
- Decimal point
- Unit
- Measurement status

If vehicles are weighed, the vehicle number, goods, procedure ID, arrival weight and departure weight are also stored.

The SD card is only accessible after the housing has been opened. In legal-for-trade applications, the housing is prevented from being opened by the adhesive calibration or sealing label.

17.1 Reading the stored files

The stored data can be displayed via the “INFORMATION → WEIGHING RESULT” parameter menu. The required result can be found and displayed with the arrow keys “F2” (↓) or “F3” (↑), or by entering the print number.

To search via the print number, enter the number to be found via the keyboard. Key “F4” deletes the search text, key  (Enter) starts the search procedure.



IMPORTANT *Print data and time are only correct if the real time clock has previously been set, see Section 8.4.7, Page 47.*

17.2 SD memory card

The DIS2116 is delivered with an installed memory card with a capacity of 1 GByte.

Maximum SD card memory capacity:	2 GByte
Maximum number of alibi print data	
in a 1GB SD card:	7.5 million
in a 2GB SD card:	15 million
Maximum number of data records in the vehicle database:	65 000
Maximum number of vehicles in Yard list:	50



If the maximum number of alibi print data is exceeded, the error 9123 is displayed. SD card is full, no further alibi print data can be saved.
Alibi print data **cannot** be deleted!



IMPORTANT *In legal-for-trade operation, the DIS2116 only works with the SD card inserted by the factory. For the device to start operating again with a new SD card, the hidden pushbutton (secured with the calibration label) must be pressed. Verified mode is left and the legal-for-trade counter is increased by 1.*

What to do if the device is faulty?

1. Open housing.
2. Remove SD card.
3. Insert SD card in new device.
4. Close housing.
5. Switch on machine.
6. Press the hidden pushbutton.
7. Set the required settings again in the menu "MODE → LEGAL-FOR-TRADE CAPABILITY".

In the case of legal-for-trade use, national legal and safety regulations must be complied with.

What to do if the SD card is faulty (legal-for-trade device)?

1. Remove seal.
2. Open housing.
3. Replace the faulty SD card with a new card.
4. Fix the replaced SD card with an adhesive strip to stop it slipping or being vibrated out.
5. Close housing.
6. Switch on the device; the SD card will be initialized with default data (alibi data and vehicle data will be lost).
7. Continue as described in Section 4.1, Page 13.
8. After commissioning is complete:
 - Press the hidden pushbutton and execute the function "CONFIGURE" in the menu "SCALE CONFIGURATION".
 - Press the hidden pushbutton again and set the required settings in the menu "MODE → LEGAL-FOR-TRADE CAPABILITY".

In the case of legal-for-trade use, national legal and safety regulations must be complied with.

**TIP**

Copy the data on the SD card after you have carried out all adjustments and settings. Should a card then become faulty, you will still have all the settings and adjustment data on the copied SD card.

18 Graphic display

The measured value (oscilloscope) or center of gravity can be graphically portrayed in the graphic display:

- The measured value from a load cell, segment or a scale consisting of several segments can be displayed.
- The center of gravity of the scale can be displayed. The center of gravity can be determined if the scale consists of at least 3 load cells.

18.1 Oscilloscope

The measured value from a load cell, segment or a scale consisting of several segments can be graphically displayed in the oscilloscope function.

Access: Key **PAR**, **INFORMATION** ← **GRAPHIC** ← **OSCILLOSCOPE** (Enter)

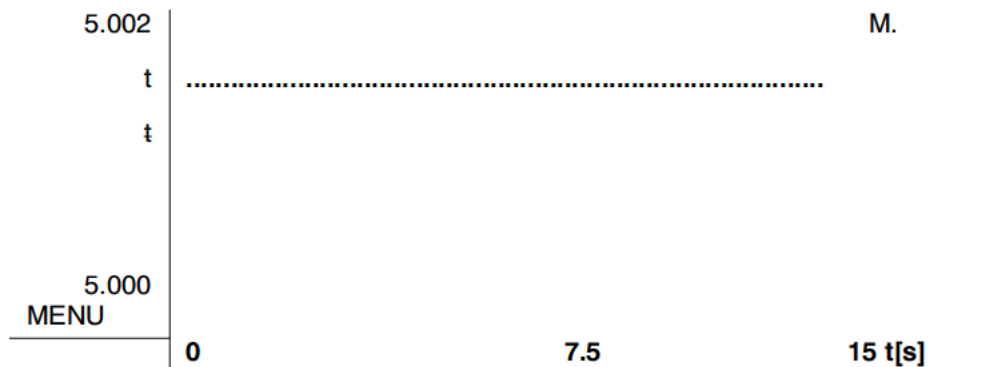

Various measured values can be displayed in the oscilloscope window. The measured values recording runs continuously and is stopped with "F1" (MENU). If the "CE" key is pressed, the recording will be continued.

If you press the key “F1” (MENU), you have two further options:

1. “F1” (FOCUS) activates the zoom function.
2. “F2” (MEASURED VALUE) activates the measured value selection.

“F1” (FOCUS)

This function can be used to look at a section of the recorded measured values. To do this, position CURSOR 1 with the keys “F1”, “F2” at the start and CURSOR 2 with the keys “F3”, “F4” at the end of the area of interest. The measured values along the Y axis will be zoomed in on. The MAX value and the MIN value of the section observed will be displayed on the Y axis.

Return to the entire recording by placing CURSOR 1 on the left edge and CURSOR 2 on the right edge.

Use “CE” to leave the FOCUS function and reset the CURSOR 1 (2) so that when “F1” is pressed again, they will be positioned on the left and right edges.

“F2” (MEASURED VALUE)

Keys “F1” and “F4” can be used to select various measured values and display them in the line graphic:





- Select the required signal (measured value) with “F1” and “F4” and confirm with .
- Exit the selection menu with “CE”.

The selected signal will be displayed in the recording window in the upper right corner. The abbreviations:

M	= Measured value of the scale
S: 1 ... 3	= Segment with segment number
A: 11	= Signal of a single load cell indicated by the address

18.2 Center of gravity

The center of gravity of a loaded scale is displayed. The scale must consist of at least 3 load cells to display the center of gravity.

Access: Key , **INFORMATION**  **GRAPHIC** 
CENTER OF GRAVITY  (Enter)

Display: Center of gravity

Center of gravity display for a scale consisting of 1 segment and 4 load cells. The individual load cells are displayed with their addresses; in this example segment 1 with the addresses 11 ... 14. The determined center of gravity is marked by an "X".

ADR:11	ADR:12
X	
ADR:14	ADR:13

No center of gravity is determined with a load < 1d, the message "No load" is displayed. "Error" is displayed if the scale platform is lifted.



IMPORTANT *To ensure that the center of gravity determination works correctly, the load cell addresses must be assigned clockwise during scale configuration as shown in the center of gravity display example above. If the scale consists of several segments, the load cell arrangement must be implemented the same way in each segment.*

Address assignment for 3 segments

ADR:11	ADR:12	ADR:21	ADR:22	ADR:31	ADR:32
Segment 1		Segment 2		Segment 3	
ADR:14	ADR:13	ADR:24	ADR:23	ADR:34	ADR:33

Center of gravity determination with 3 segments as a compound scale

ADR:11	ADR:32
X	
ADR:14	ADR:33

Only the outer 4 load cells are shown in the center of gravity window.

19 Parameter factory settings

When the DIS2116 is delivered, it comes with a registered production number (7 digits). As the DIS2116 has undergone certain tests during production, the following information can deviate from zero:

- Legal-for-trade counter (Menu "INFORMATION → SCALE" or "F1" key with symbol i)
- Sensor overflow counter ("INFORMATION → BUS SCAN" menu)

Parameter	Default	Explanation
Limit values 1 ... 2		Switched off
Filter mode	0	Standard filter
Filter	5	0.3 Hz (AD104C, C16i)
Manual tare value	0	Switched off
COM1, baud rate	38400	
COM1, parity bit	even	
COM2, COM3, COM4, function	OFF	Switched off
COM2, COM3, COM4, baud rate	9600	
COM2, COM3, COM4, parity bit	even	
Printing, ESC sequences	0	Switched off
Basic scale function	Standard	Non-automatic weighing instrument
Menu access	5	All menus
Legal-for-trade operation	OFF	Switched off
Unit	OFF	No unit of measurement
Zero on start-up	OFF	Switched off
Zero tracking	OFF	Switched off
Standstill monitoring	OFF	Switched off
Digit / increment	1d	
Decimal point	0	Right
Nominal (rated) load	10000	
Multi-range weighing machine	0	Switched off
Calibration weight	10000	Maximum capacity adjustment
Gravitational acceleration correction	9.8102	Switched off
Scale char. curve, zero	0	
Scale char. curve, nom. value	10000	At load cell maximum capacity
Linearization		switched off

When restoring to the factory settings ("FACTORY SETTINGS" menu), the parameters described above are set to their default values.

20 Monitoring functions and error messages

20.1 Monitoring functions

The following monitoring functions are implemented for load cell connection:

- Detecting whether a load cell is connected to COM1.
- Detecting failure of a load cell.
- Sensor input signal exceeds the range -160% ... +160% of the maximum capacity (NOMINAL VALUE).

The following monitoring functions are also available:

- Error in parameter storage (SD card)

Error message display:

To indicate an error, [Errxxxx] appears on the display for 3s (xxxx is the error code). The last ten errors can also be read in the parameter menu ("INFORMATION → ERROR LIST").

Error message	Significance	Remedy
Display shows -----	Measured value is outside the max. display range (depending on the set scale standard)	Reduce the scale loading. Check set maximum capacity: "NOMINAL VALUE" parameter in menu "SCALE PARAMETERS → PARAMETER".
Display shows XXXXXXXXXX	Verification error: Serial number of LC not identical with verification Legal-for-trade counter status in LC not identical to verification	Load cells were replaced or adjusted. Scale must be verified again.

LC = load cell or AD104C

20.2 Error messages

The error code number is split into two sections. The first number determines the error group (the area in which the error occurred), the following three numbers the precise cause.

Error code	Description
Err xxxx	Error message in display
Error group	(First character)
1	Bus scan
2	Load cell initialization
3	Load cell parameter check
4	No function
5	Measurement
6	Off-center load compensation
7	Database
8	COM1/2/3/4 interfaces
9	Hardware

BusScan		
Error code	Description	Remedy
10xx	Error in BusScan ADRxx, no response (time out) e.g.: 1011: Error at address 11 (Segment 1 No. 1)	Check serial number in menu "SCALE CONFIGURATION", then carry out bus scan
11xx	Error in BusScan ADRxx, incorrect response (NAK) e.g.: 1011: Error at address 11 (Segment 1 No. 1)	Check the cables Check load cell interface Check DIS2116 interface
12xx	Serial number not entered	Check serial number in menu "SCALE CONFIGURATION", then carry out bus scan
13xx	Double assignment of serial number	

Init_Load cells		
Error code	Description	Remedy
2000	FMD error	Carry out bus scan or test load cells ("FUNCTION TEST" menu)
2001	ASF error	
2002	LIV1 error	
2003	LIV2 error	
2004	TAS1 error	
2005	TAV0 error	
2006	MRA0 error	
2007	CWT1000000 error	
2008	MTD0 error	
2009	Error ENU"d"	
2010	ZSE0 error	
2011	ZTR0 error	
2012	HSM0 error	
2013	DPT0 error	
2014	NOV1000000 error	
2015	COF8 error	
2016	LIC0,1000000,0,0 error	
2017	CSM2 error	
2018	NTF error	
2019	RSN1 error	
2020	ICR0 error	

Test_Load cells		
Error code	Description	Remedy
30xx	IDN PART1 error (Manufacturer code), ADRxx	Check parameters, re-enter if necessary (new calibration/verification) or replace load cell
31xx	Error IDN TEIL3 (F number), ADRxx	
32xx	TCR? read error, ADRxx	
33xx	LFT error, ADRxx	
34xx	LDW/LWT error, ADRxx	
35xx	SZA/SFA read error, ADRxx	
36xx	CRC error, ADRxx	
37xx	Type error, ADRxx	
38xx	GCA error, ADRxx	
39xx	GDE error, ADRxx	

Other		
Error code	Description	Remedy
4001	Invalid load cell address	Check the entered address in the parameter menu "SCALE PARAMETERS → REPLACE LOAD CELLS → LOAD CELL ADDRESS". A valid address must be entered. Example: 11 to 14 are valid address for 1 segment and 4 load cells.
4002	Printer error	Check connection to printer. Check settings in parameter menu "COMMUNICATION → PRINTER → PROTOCOL" (DTR/DC1).

Measurement		
Error code	Description	Remedy
50xx	Load cell with address xx not supplying measured value	Carry out bus scan or test load cell ("FUNCTION TEST" menu), emergency operation possible if only one load cell fails per segment
51xx	Load cell with address xx has incorrect F number	Check parameters, re-enter if necessary (new calibration/verification) or replace load cell
52xx	Load cell with address xx has incorrect TRC status	Check parameters, re-enter if necessary (new calibration/verification) or replace load cell
53xx	Load cell with address xx overloaded	Check load/scale adjustment
5701	Vehicle empty weight > Weighing2 result	Check vehicle data, repeat measurement if necessary
5702	Weighing result < minimum vehicle weight	Adjust minimum vehicle weight, load vehicle
5703	Weighing result > maximum vehicle weight	Adjust maximum vehicle weight, vehicle is overloaded
5801	Measured value < MIN	Printout started with measured value < MIN, scale loaded
5803	Printout 2x	The scale must be relieved after a measured value printout before a new printout is possible. (The standstill bit must be deleted.)
5804	Overflow of legal-for-trade counter TCR	Send in the device
5805	Display range overrun	The measured value must lie within the valid display range, see Section 7.8, Page 32

Off-center load compensation		
Error code	Description	Remedy
6001	Measured value differences in corners too large	Check scale construction
6002	Zero point outside range, off-center load cannot be compensated	
6003	Nominal value outside range, off-center load cannot be compensated	

Database		
Error code	Description	Remedy
7001	Yard list full (50 entries)	
7002 7003 7004	Database error	Repair database (parameter menu "FACTORY SETTINGS → DATABASE")

COM1 to 4 interfaces		
Error code	Description	Remedy
8x01 ¹⁾	Input buffer overflow	Run a bus scan
8x02 ¹⁾	Overflow Possible causes: Incorrect baud rate, parity settings	
8x03 ¹⁾	Parity error Possible causes: Incorrect baud rate, parity settings	Run a bus scan
8x04 ¹⁾	Framing error Possible causes: Incorrect baud rate, parity settings	
8x05 ¹⁾	Framing error Possible causes: Incorrect baud rate, parity settings	
8600	COM1: Response "?"	Check connection
8601	COM1: Response defective	
8602	COM1: Timeout	

¹⁾ x represents the interface e.g. Error 8101 is an error at COM1, Error 8201 is an error at COM2, etc.

Hardware		
Error code	Description	Remedy
9100	SD card error	Replace SD card
9123	SD card full, no further alibi print data can be saved	
9200	EEPROM error	
95xx	ESR error, BIT2 (ADC OVFL), ADRxx	Replace load cell
96xx	ESR error, BIT3 (EEPROM), ADRxx	
97xx	ESR error, BIT4 (bridge excitation voltage), ADRxx	
98xx	ESR error, BIT5 (parameter entry), ADRxx	Test load cell ("FUNCTION TEST" → LOAD CELL → LOAD CELL TEST" menu)

The battery is only important for the real-time clock function, the device can function without a battery. In this case, the date and time have to be reset after a power failure (see Section 8.4.7 (Page 47)).

21 Specifications

Type		DIS2116
(NAWI) (non-automatic weighing instrument)		
Voltage supply U_B		
Area	V _{DC}	10 ... 30 (24 nominal)
Power consumption (without outputs)	W	0.88
Power consumption (at 24 V)	mA	40
Load cell connection		
RS-485 interface COM1		
Supply voltage OUT1	V _{DC}	10 ... 30
Output current	A	<1
Supply voltage OUT2 (C16i)	V _{DC}	10 ... 17
Output current	A	<1
Maximum cable length	m	see table in Specifications appendix
Display		
LCD with backlighting and status symbols	Pixel	240x64
Character height (measured value)	mm	8
Output rate	1/s	5
Keys		
Number		15
Function keys		4
Serial interface (COM1), load cells		
Baudrate	Bd	9600, ..., 115200
Parity bit		Even
Data bits	Bit	8
Stop bit	Bit	1
Type		RS-485 (2/4-wire)
RS-485 2-wire, signals		TRxA, TRxB
RS-485 4-wire, signals	-	TRA, TRB, TXA, TXB
RS-485, max. cable length	m	500
Serial interface (COM2), PC/PLC		
Baudrate	Bd	1200, ..., 115200
Parity bit		Even, odd, none
Data bits	Bit	8
Stop bit	Bit	1
Type		RS-232
RS-232, signals		RxD, TxD, GND
RS-232, max. cable length	m	25

Serial interface (COM3), Printer		
Baud rate (RS-232)	Bd	1200, ..., 115200
Parity bit (RS-232)		Even, odd, none
Data bits (RS-232)	Bit	8
Stop bit (RS-232)	Bit	1
Type		RS-232
RS-232, signals		RxD, TxD, GND, DTR
RS-232, max. cable length	m	25
USB (COM3), Printer		
Max. cable length	m	5
Printer language		PLC
Serial interface (COM4), second display		
Baud rate (RS-232)	Bd	1200, ..., 115200
Parity bit (RS-232)		Even, odd, none
Data bits (RS-232)	Bit	8
Stop bit (RS-232)	Bit	1
Type		RS-232
RS-232, signals		RxD, TxD, GND, DTR
RS-232, max. cable length	m	25
PS/2 interface, standard keyboard		
Output current	mA	< 100
Ambient conditions		
Temperature range		
Nominal (rated) temperature range	°C	-10 ... +40
Operating temperature range	°C	-20 ... +60
Storage temperature range	°C	-30 ... +80
relative humidity, non-condensing		
in operation	%	20 ... 85
Storage	%	10 ... 90
DIS2116 housing		
Degree of protection per EN 60529 (IEC 529)		IP20
Degree of protection per EN 60529 (IEC 529) for front panel when installed		IP65
Material		Aluminum
Weight, approx.	g	540

The DIS2116 is not sensitive to HF irradiation and conducted interference in accordance with OIML R76, EN45501:1992(B3), EN 61326: 2006 Emission Class B, Interference immunity: Industrial environment.

Maximum cable lengths¹⁾ between DIS2116 and C16i load cells(s)

IF the DIS2116 supply voltage is less than 17 V, the digital load cells can be supplied directly from the scale electronics. Please refer to the following table for the layout. The load cells must be supplied separately with the (nominal) supply voltage of 24 V.

		Nominal voltage 12 V _{DC}			Nominal voltage 15 V _{DC}		
		Wire cross-section (in mm ²)					
		0.14	0.25	0.5	0.14	0.25	0.5
Number of load cells	Total current consumption (in mA)	Cable length (in m)					
1	50	393	500	500	500	500	500
2	100	197	350	500	315	500	500
3	150	131	234	468	210	375	500
4	200	98	176	351	157	281	562
6	300	66	117	234	105	187	375
8	400	49	88	176	79	140	281
10	500	39	70	140	63	112	225
12	600	33	59	117	52	94	187
16	800	25	44	88	39	70	140

¹⁾ The cable length is limited to max. 500 m.

22 Dimensions

22.1 DIS2116 and panel frame cutout dimensions

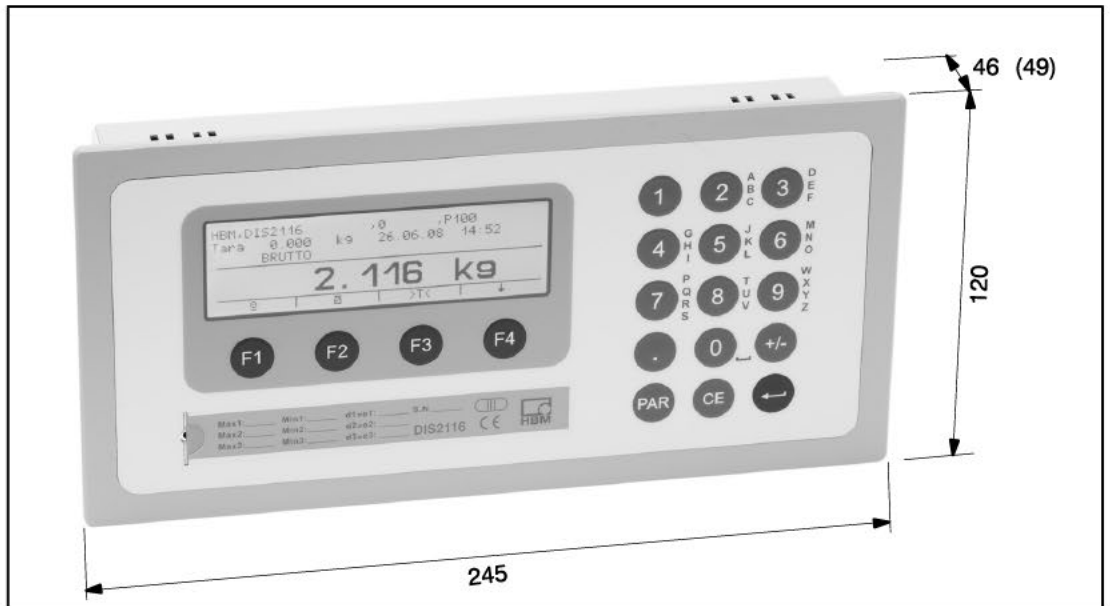

Fig. 22.1: DIS2116 dimensions

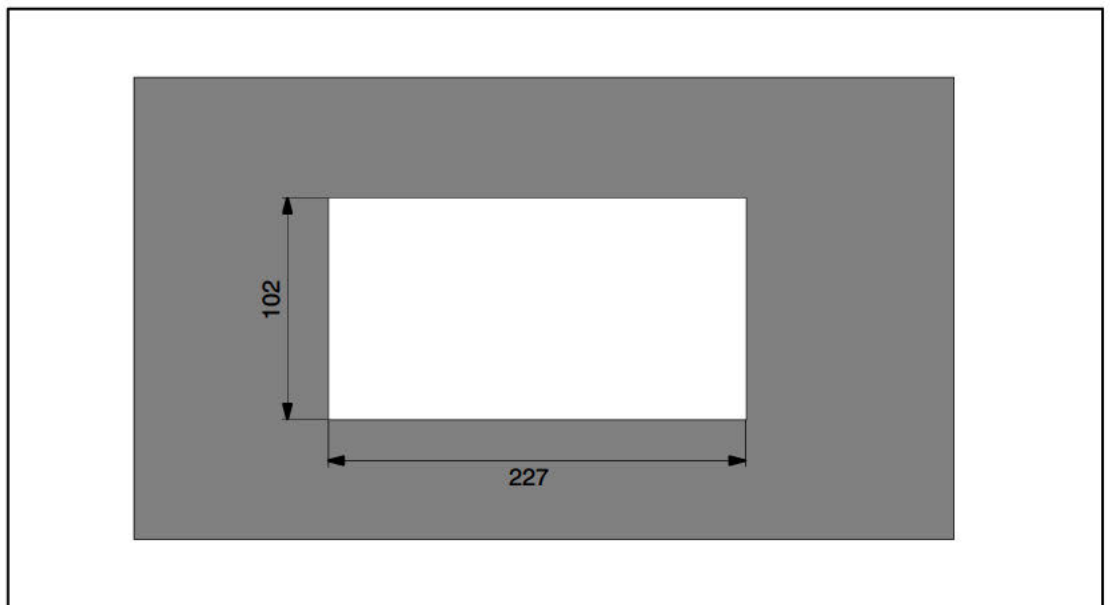

Fig. 22.2: Dimensions for the panel frame cutout

22.2 Desktop housing, also for wall-mounting (1-TG2116)

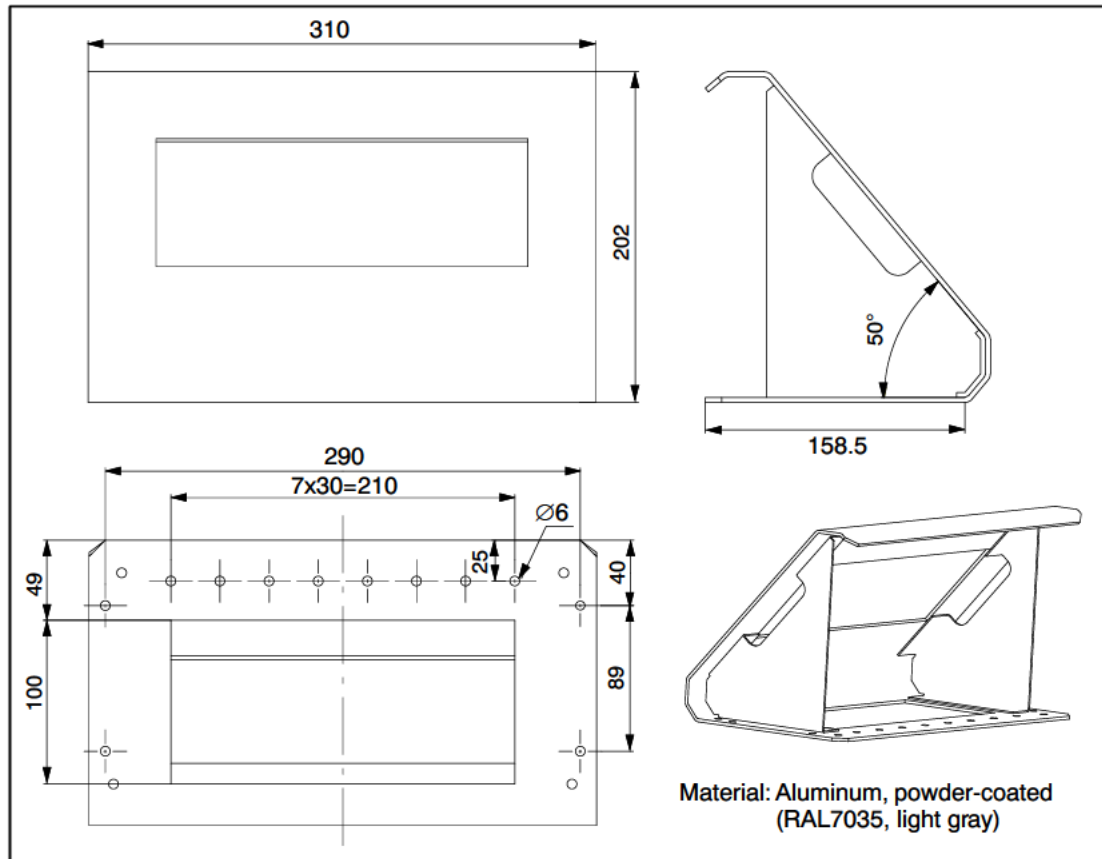

Fig. 22.3: Desktop dimensions, Order no.: 1-TG2116

Index

A

ACCESS LEVEL, 83
Activating COM4 for a second display, 101
Activating the printer interface, 92
Alibi memory, 105

B

Basic scale functions, 28

C

Cable connection, 16
Cable entry, 16
Cable preparation, 12, 17
Calibration memory, 105
Calibration weight, 69
Center of gravity, Graphic display, 110
Characteristics, 10
COM3 (printer interface), 92
COM4 (second display), 101
Configuration, 65
Control elements, 26
Create vehicle, 89

D

Delete vehicle, 89
Desktop housing, Dimensions , 122
Device view, 25
Dimensions, 121
DIS2116 – printer connection, 93
Display, 26
 for vehicle weighing, 86
 of measured values (graphic), 108
Display functions, 25
Display illumination, 27
Dual-range balance, 80

E

Editing vehicle data, 88
Electrical connections, 16
Error displays, 32
Error effect, 80
Error messages, 113

F

Filter selection, 64
Four-wire circuit, 20

G

Graphic display, 108
Gravitational acceleration factor, 80
Gross/net selection, 30

H

Hidden pushbutton, 25

I

Initial commissioning, 13
Initial operation, 13

K

Keys, 26

L

Legal-for-trade applications, 83
Limit value switch, 104
 Parameters for limit values, 104
Limit values, 104
Linearization, 81
Linearization method, 81

Load cell connection, 20
 Load cell maximum capacity, 70
 Load cell sensitivity, 70

M

Main menu, 35
 Manual tare function, 31
 Manual tare value, 31
 Manufacturer's notes, 9
 Maximum capacity adjustment
 Computational adjustment, 70
 Maximum capacity adjustment with calibration weight, 68
 Maximum capacity adjustment without calibration weight, 70
 Maximum capacity of the scale, 69, 71
 Mechanical construction, 11
 Menu structure, 38
 Multi-range weighing machine, 80

N

Navigation via device keys, 36
 Navigation via external keyboard, 37
 Nominal range, 67

O

Off-center load compensation, 72
 Adjustment mode "AVERAGE", 75
 Adjustment mode "INPUT", 79
 Adjustment mode "PRECISE", 77
 Adjustment mode "SIMPLE", 73
 Operating function, 25
 Operating voltage, 20
 Oscilloscope, 108

P

Panel frame cutout, 121

Parameter factory settings, 111
 Parameter menu, 36
 Access restriction, 34
 Calling the parameter menu, 34, 112
 Disabling menu functions, 34
 Enabling menu functions, 34
 Navigation in levels 1 and 2, 89
 Navigation in the parameter menu, 36
 The main menu, 35
 Partial calibration, 69
 Passcode protection, 34
 Print function, 92
 Print protocols, 94
 Printer
 Activating the interface, 92
 connection, 93
 Print protocol selection, 93
 Printing, Automatic printing, 100

R

Read out SD card data, 105
 RS-485 interface, 21

S

Scale adjustment, 65
 Requirements, 67
 with digital off-center load compensation, 72
 Scale adjustment with maximum capacity, 68
 Scale adjustment with partial load, 69
 Scope of delivery, 11
 SD memory card, 106
 Second display, 101
 Serial interface, 23, 24
 Single-range balance, 80
 Six-wire connection, 20
 Specifications, 118
 Standstill recognition, 33
 Starting the printing process, 99

Sub-menu

CLOCK, 47
COMMUNICATION, 43
DISPLAY, 49
FACTORY SETTINGS, 62
FILTER, 42
FUNCTION KEYS, 48
FUNCTION TEST, 50
LIMIT VALUE, 41
LIMIT VALUE 1, 41
LIMIT VALUE 2, 42
MODE, 52
OFF-CENTER LOAD COMPENSATION, 61
PRINT, 39
PRINT-> MEASURED VALUE, 39, 40
PRINT -> PARAMETERS, 40
PRINT PROTOCOL, 46
SCALE CONFIGURATION, 55
SCALE PARAMETERS, 56

Submenu, INFORMATION, 38

Switching off, 28

Switching on, 28

T

Taking gravitational acceleration into account, 80

Taring, 30, 31

Terminal block 1, 21

Terminal block K1 assignments, 22

Three-range scale, 80

U

Usage, 9

V

Vehicle scale, 86

Vehicle weighing, Edit database, 87

Vehicle weighing mode "ARRIVAL/DEPARTURE", 90

W

Weighing range, 71

Z

Zero on start-up, 32

Zero setting the scale, 29

All rights reserved.
All details describe our products in general form only.
They are not to be understood as express warranty and
do not constitute any liability whatsoever.

托驰（上海）工业传感器有限公司
上海市嘉定区华江路348号1号楼707室
电话：+86 021 51069888
传真：+86 021 51069009
邮箱：zhang@yanatoo.com
网址：www.sensor-hbm.com

measure and predict with confidence

